



CI 70



ART.NR. 116402

EN**ASSEMBLY AND USER INSTRUCTIONS**

Control panel

*Our products are subject to continuous development and we therefore reserve the right to make changes.
We also disclaim liability for any printing errors that may occur.*

Contents

1.	Scope	4
2.	Mechanical design.....	4
2.1.	Mounting.....	5
3.	Icon description.....	8
3.1.	Status icon description:.....	9
4.	Sleep page & home page description.....	10
4.1.	Layer concept	11
5.	Settings	11
5.1.	General description	11
5.2.	Adjust time date & scheduler	12
5.3.	Fan speeds	13
5.3.1.	Fan speed setting page	13
5.4.	Supply air temperatures	14
5.4.1.	Home page – mode selection	14
5.4.2.	Home page – home/away selection	15
5.4.3.	Home page – in scheduler mode.....	15
5.4.4.	Timer functions.....	16
5.5.	Information.....	16
5.6.	Alarm.....	17
5.6.1.	Alarm mode.....	17
5.6.2.	Filter alarm.....	17
5.6.3.	Reset filter timer.....	18
5.6.4.	Filter interval.....	18
5.6.5.	Acknowledge and reset A-Alarm	19
5.6.6.	Acknowledge B-Alarm	19
5.6.7.	Alarm codes.....	20
5.6.8.	Alarm codes – Hardware related errors.....	20
5.6.9.	Alarm codes – Application related errors	21
5.6.10.	Alarm codes – Communication errors.....	21
5.6.11.	Alarm codes – 3rd party related errors.....	22
5.7.	Expert mode	23
5.7.1.	Read parameter mode	23
5.7.2.	Parameter list.....	24
6.	Technical data.....	25
6.1.	Mechanical dimensions.....	25
6.2.	Specification.....	25
6.3.	Maintenance	27
6.4.	Disposal.....	27

1. Scope

- The CI 70 operates control functions, such as fan and temperature control
- The CI 70 communicates with 2-wire interface to the controller through KNX PL-Link

2. Mechanical design

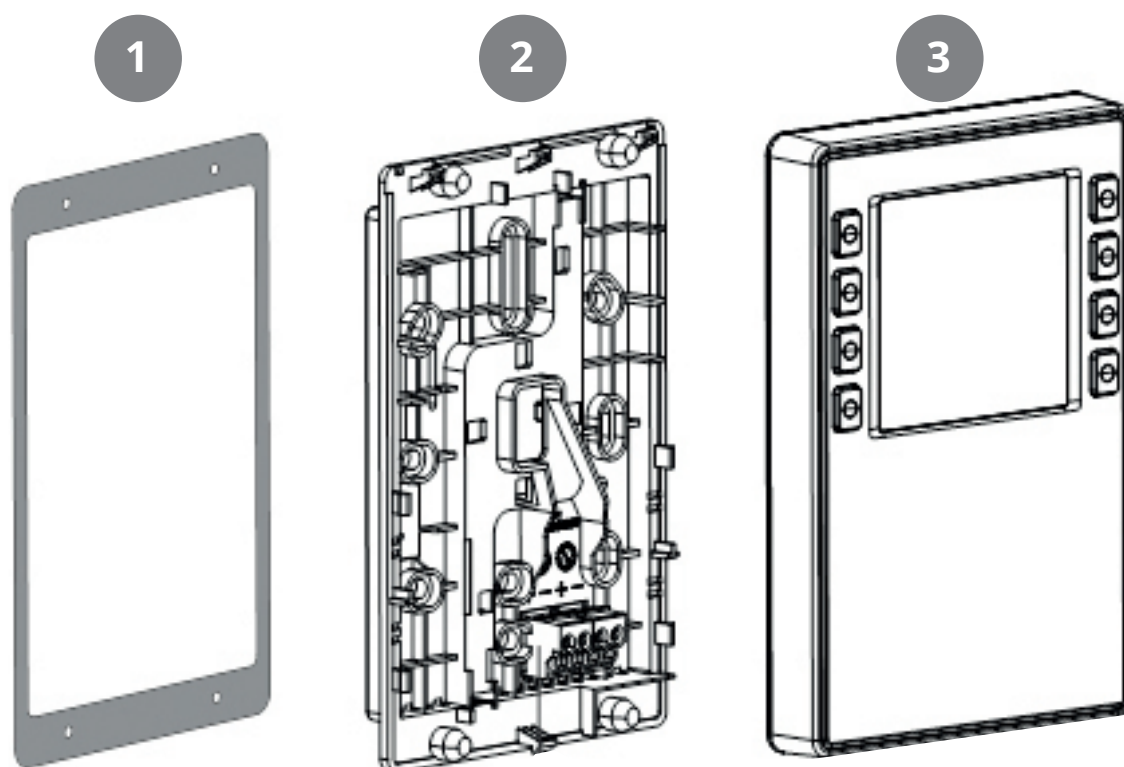

1	Gasket for panel mounting
2	Base plate
	• with screw holes for all common conduit axes
	• with gaining channels for wiring from center, up, or bottom
3	Operator unit

i The subsections include important information that is either decisive for the sale or is essential for engineering.

! **National safety regulations**
 Failure to comply with national safety regulations may result in personal injury and property damage

- Observe national provisions and comply with the appropriate safety regulations.

2.1. MOUNTING

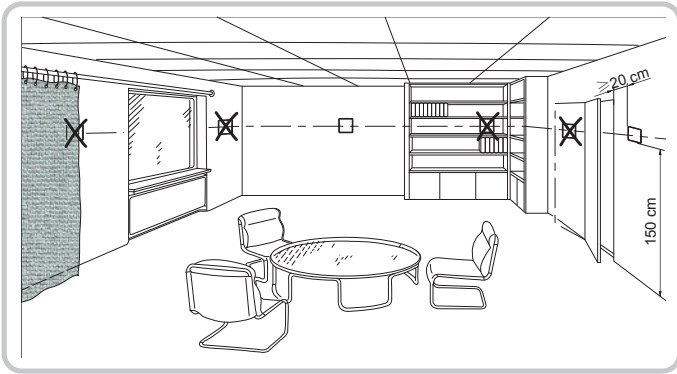

- The devices are suitable for wall mounting and panel mounting.
- Recommended height: 1.50m above the floor.
- Do not mount the devices in recesses, shelves, behind curtains or doors, or above or near heat sources.
- Avoid direct solar radiation and drafts.
- Seal the conduit box or the installation tube if any, as air currents can affect sensor readings.
- Adhere to designated ambient conditions.

The cable to the control panel is laid between the ventilation unit and the control panel.
The control panel is designed for concealed installation above the wallbox.

The included cable is 12 meters. If you need a longer signal cable, order our 24 m cable. Art.no. 118258.



The cable to the CI 70 control panel must be at least 30 cm from the 230 V cable (including dimmers, thermostats, etc.). Power cables must cross the CI 70 signal cable at a right angle. For concealed installation, the cable is laid in 16 mm cable tubes.

When you have installed the signal cable, pull out all cable at the CI 70 panel to avoid surplus signal cable at the ventilation unit. A roll of cable at the unit may cause disruption. Cut the signal cable to the right length before the next step.



CI 70 control panel must be connected to the ventilation unit before powered ON. After power ON it takes approx. 3 min before the control panel is in operation.

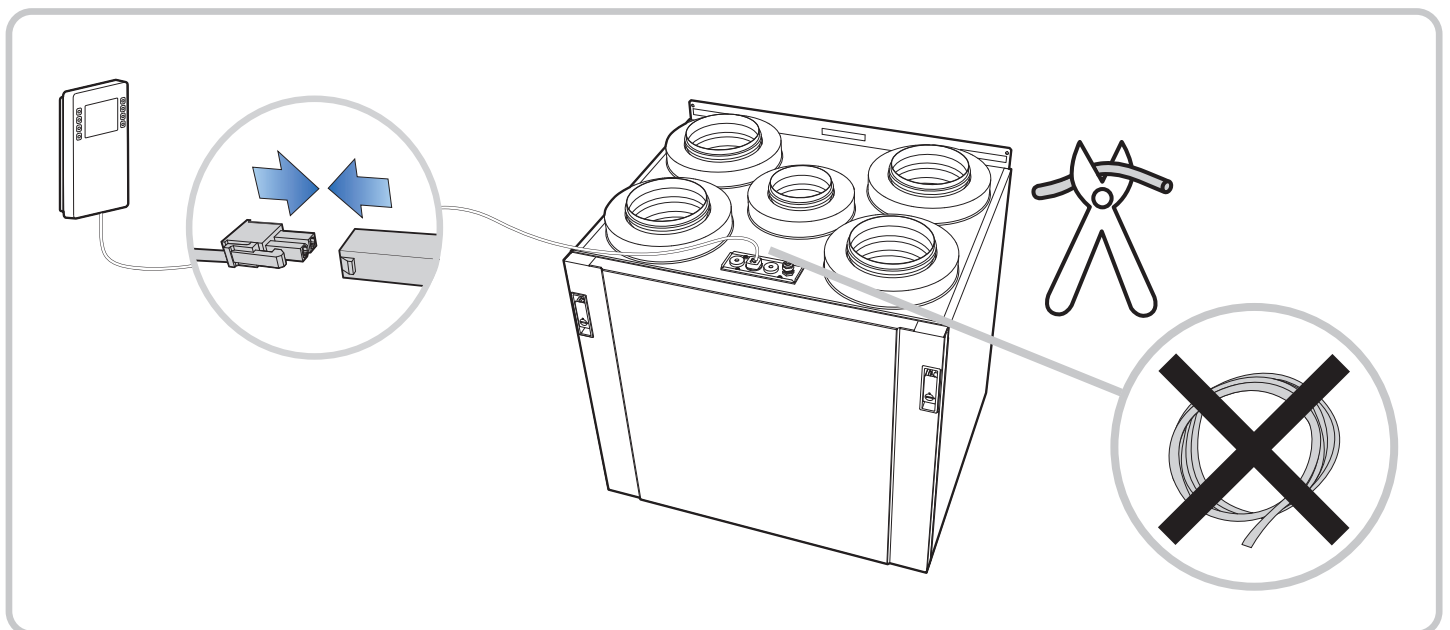

1

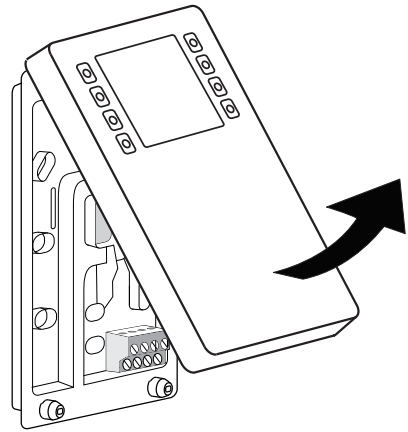
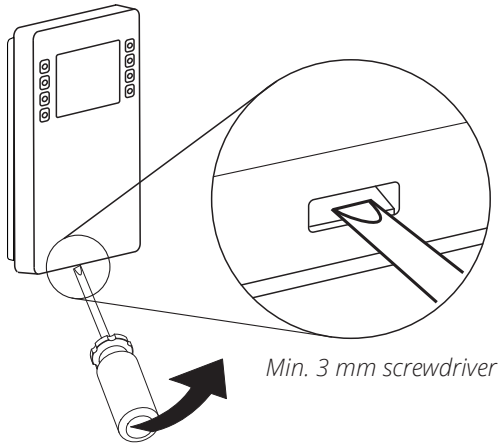

2

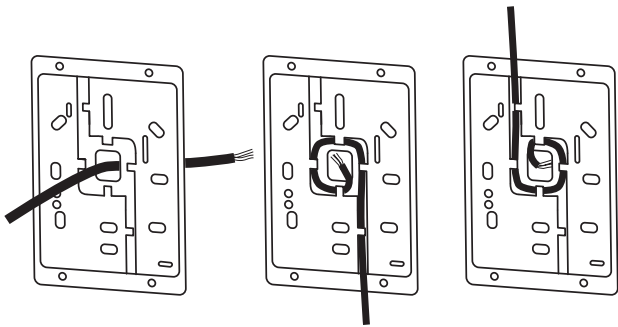

3

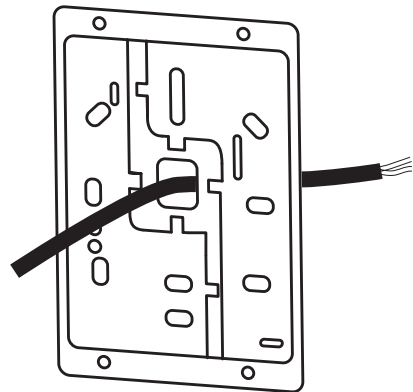
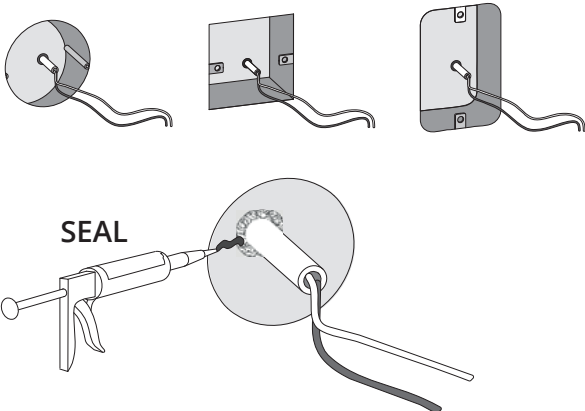

4

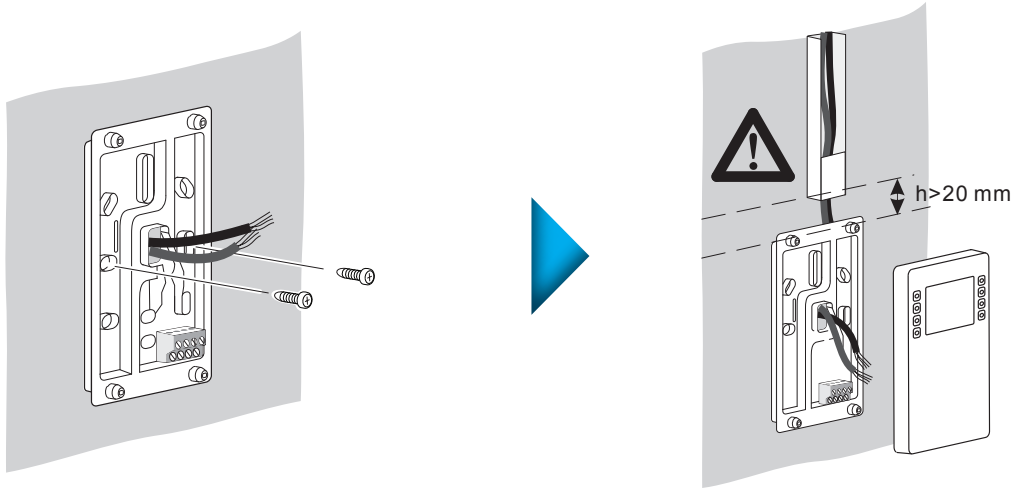

5

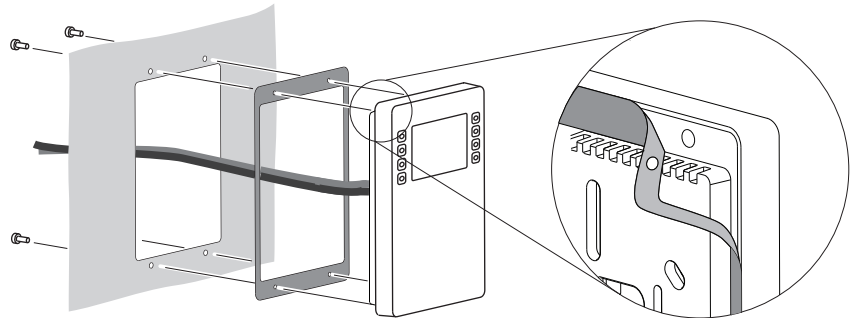
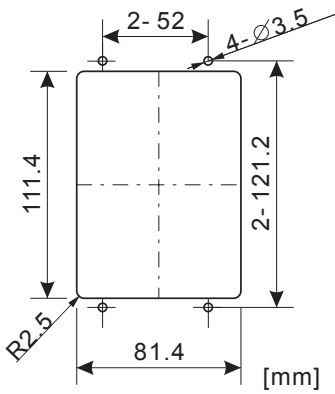

6

Connector

Pin Description

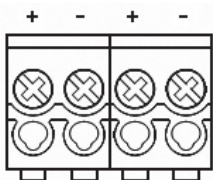

- + KNX PL-Link (positive)
- KNX PL-Link (negative)
- + brown cord
- white cord







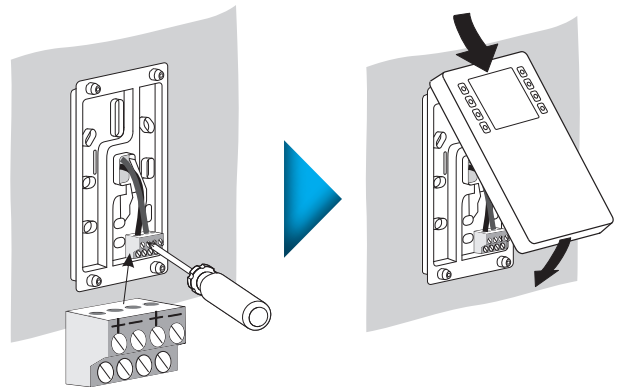





















NOTICE! Installer can choose either pair of the pins to connect.



Wires are NOT interchangeable!
The device is protected against faulty wiring, but communications does not work on interchanged wires.





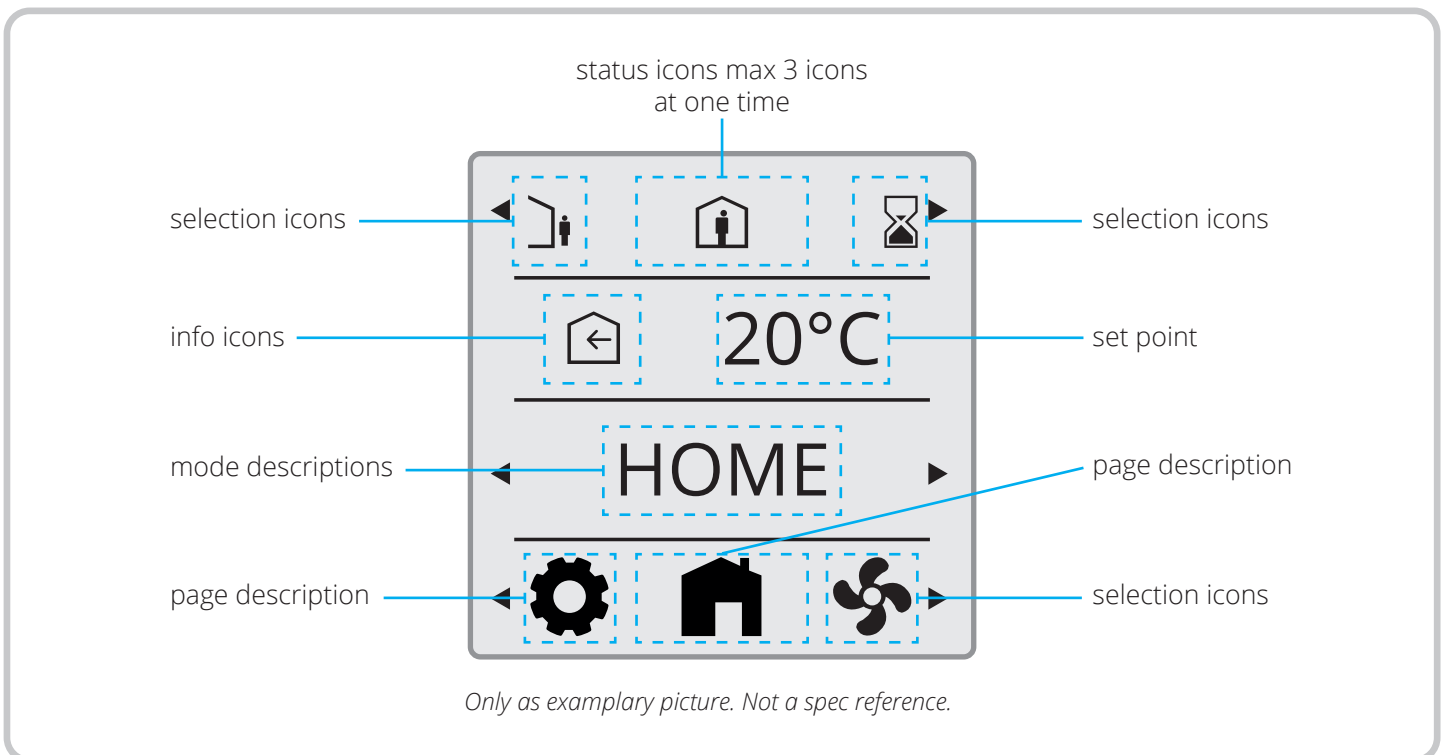

3. Icon description



-  AUTO MODE
-  HOME PAGE
-  AWAY MODE
-  HOME MODE
-  HIGH MODE
-  FIRE PLACE MODE
-  COOKER HOOD MODE
-  SUPPLY AIR
-  EXHAUST AIR
-  FAN SPEED SETTINGS
-  ROOM TEMPERATURE
-  GENERAL SETTINGS
-  CONFIRM
-  CANCEL
-  TIMER MODE
-  ELECTRICAL HEATER ENABLED
-  ELECTRICAL HEATER DISABLED
-  GO BACK
-  ALARM
-  ALARM - NOT ACKNOWLEDGED
-  ALARM - ACKNOWLEDGED
-  NORMAL - ACKNOWLEDGED
-  SERVICE REQUEST
-  SERVICE - NOT ACKNOWLEDGED
-  SERVICE - ACKNOWLEDGED
-  READ PARAMETER MODE
-  CONFIRM ALARM
-  INDICATES AN OPERABLE ELEMENT



3.1. STATUS ICON DESCRIPTION:



Position 1

-  ALARM
-  ALARM – NOT ACKNOWLEDGED
-  ALARM – ACKNOWLEDGED
-  NORMAL - ACKNOWLEDGED BUT NOT RESETED

-  SERVICE REQUEST
-  SERVICE – NOT ACKNOWLEDGED
-  SERVICE – ACKNOWLEDGED

-  AUTO MODE

Position 2

-  AWAY MODE
-  HOME MODE

Position 3

-  HIGH MODE

Status icons max 3 icons at one time

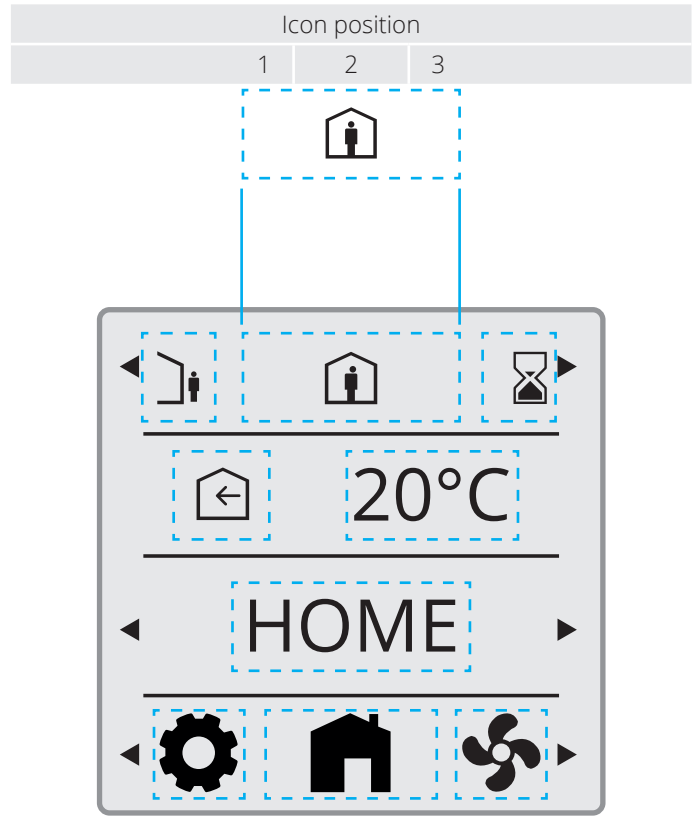

Only as exemplary picture. Not a spec reference.

4. Sleep page & home page description

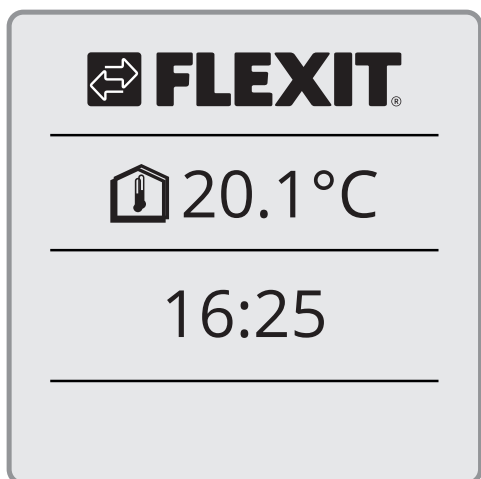

Sleep page

Displays the room temperature at the panel. NB. If the panel is installed in a cold room, the temperature may differ from the indoor temperature elsewhere.

Display actual time.



Home page

Backlight switches off after no usage in 3,5 min.
Display returns to sleep page after no usage in 4,0 min.

Display supply air temperature setpoint according to operating mode.

Display actual W mode.
Selection of different modes possible.

Select settings pages.

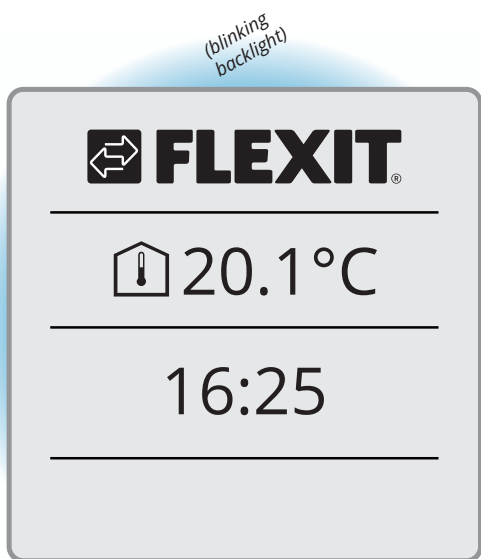

B-alarm
See section 5.6



A-alarm
See section 5.6

4.1. LAYER CONCEPT

Screens/views are prioritized according to use cases. When screen with higher prio is called/activated it will be the dominant one.

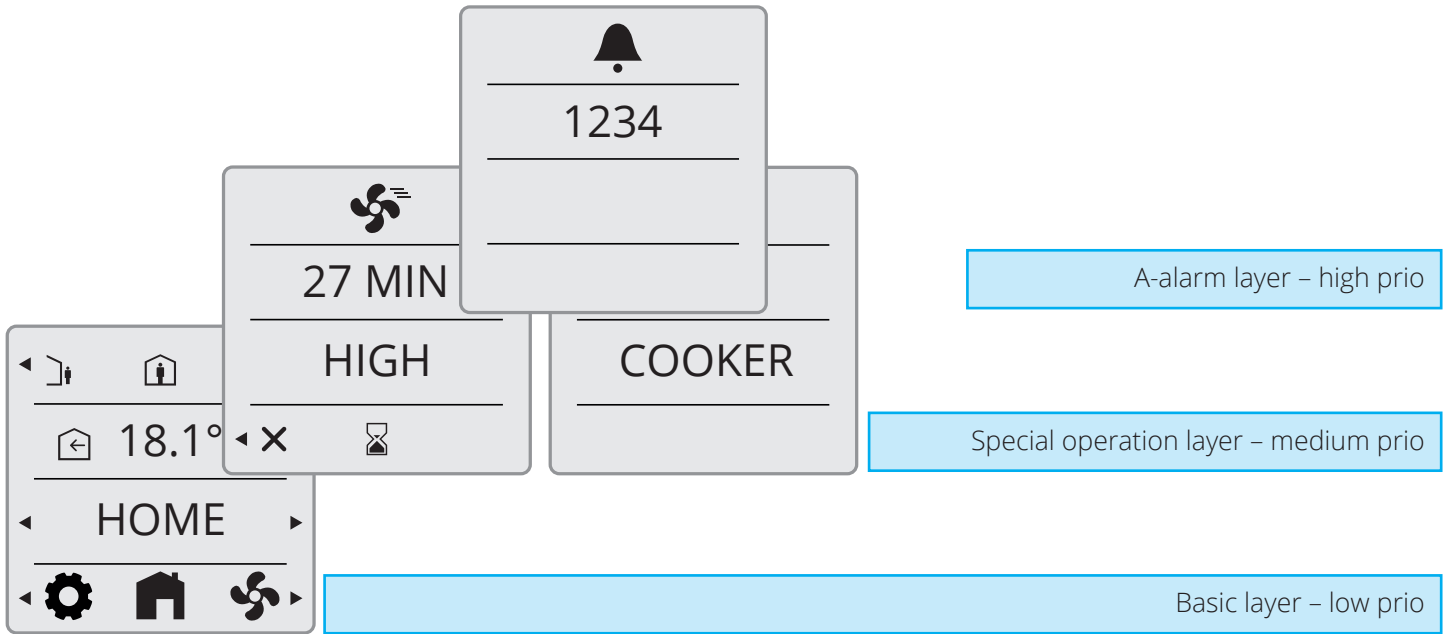

5. Settings

5.1. GENERAL DESCRIPTION

Each page explained later in detail.

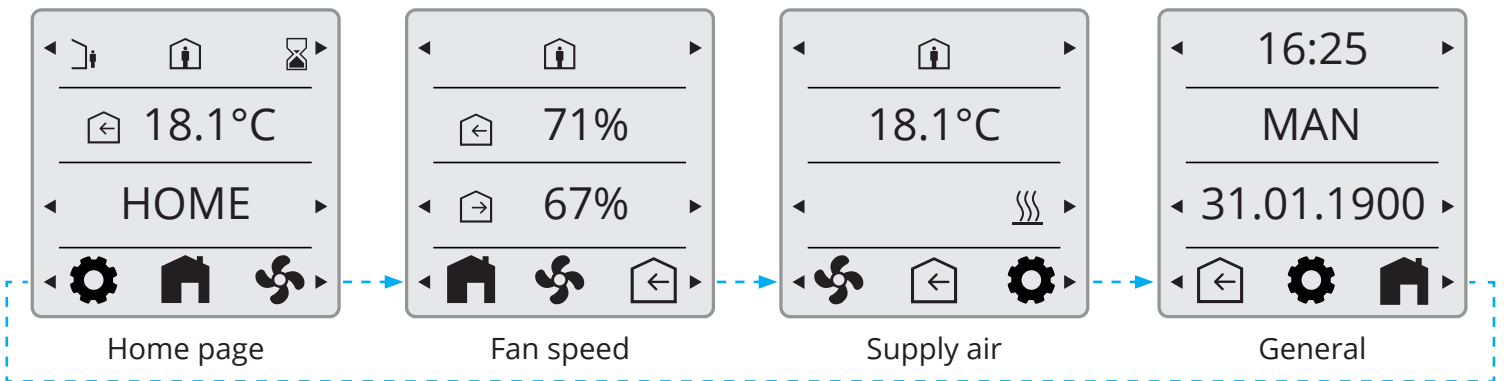

5.2. ADJUST TIME DATE & SCHEDULER

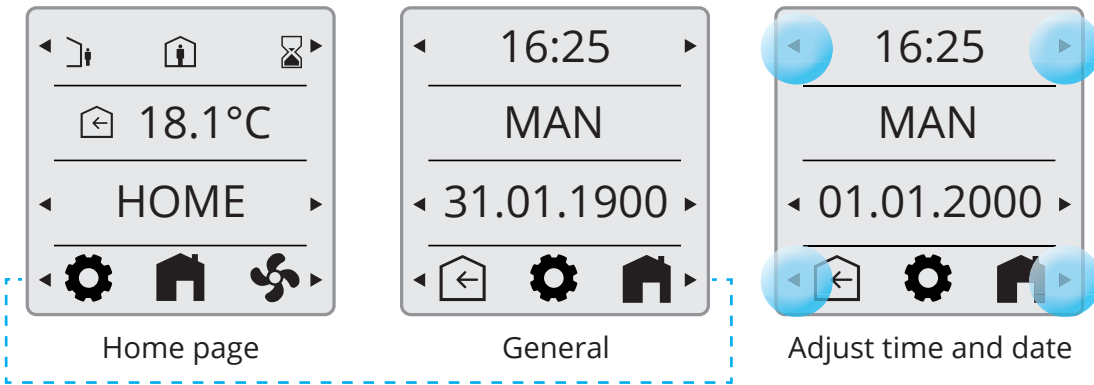

Adjust time:

Press the arrows beside the clock: <- to reduce and -> to increase the time. Hold down to move faster.

Adjust the date:

Press the arrows beside the date: <- to reduce and -> to increase the date and year. Hold down to move faster.

Adjusting MAN/AUTO:

Via the FlexitGO app, you can set the unit to operate in calendar mode, i.e. it changes speed according to a preset timetable. You can select whether the unit will operate in calendar mode via the panel. This is done by selecting HOME mode and then going to General mode (see 5.1). Use the arrows to switch between:

MAN = Calendar off

AUTO = Calendar active if it is configured in the app.

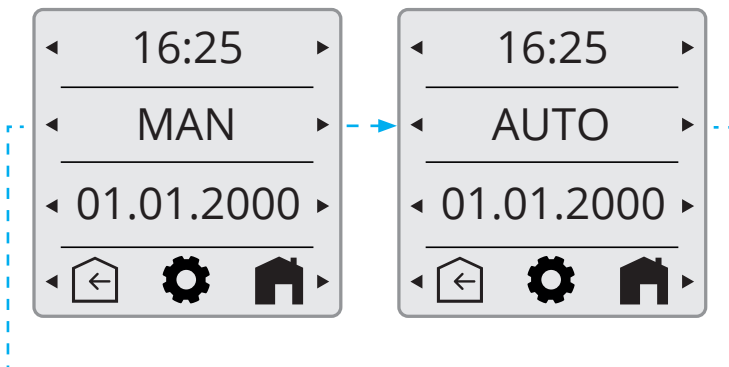

5.3. FAN SPEEDS

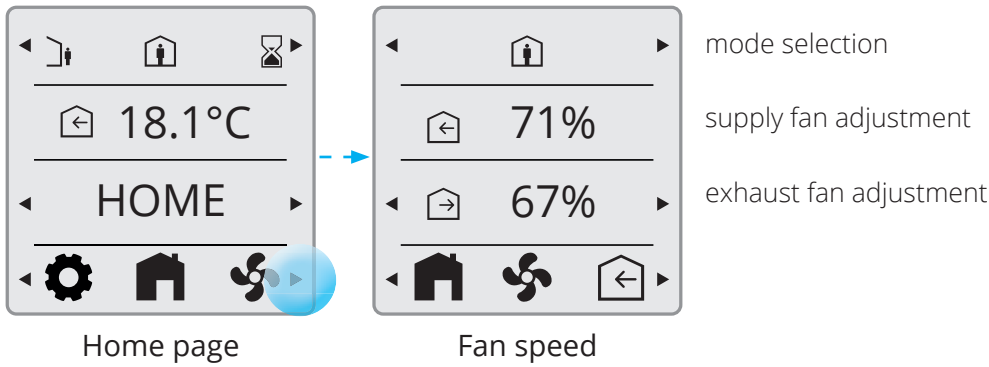

NB. The fan speeds are factory-set to: Away 50%, Home 75% and High 100%. High must always be set higher than Home, which must be set higher than Away. For example, if you want to set Home lower than 50%, you must first reduce Away so it is always lower than Home. The same applies between Home and High.

5.3.1. Fan speed setting page

Press of button 5 will change the views in loop towards right.

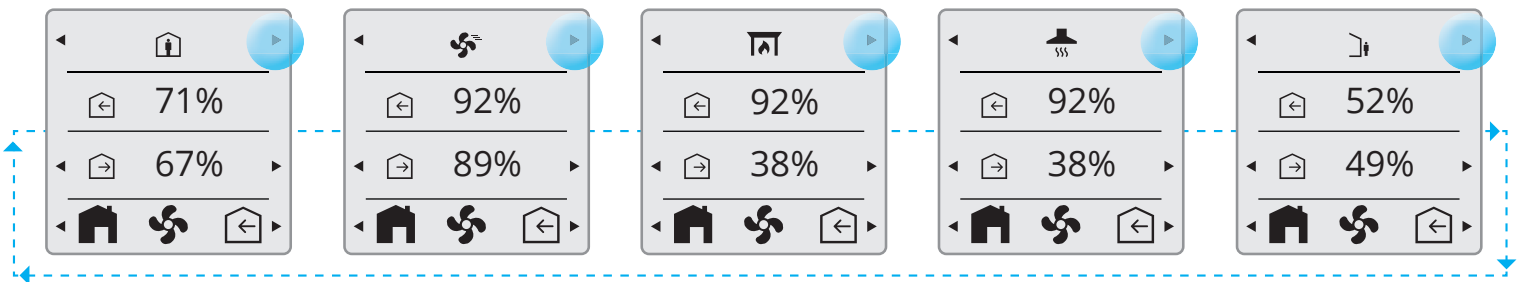

Press of button 1 will change the views in reverse order - loop towards left.

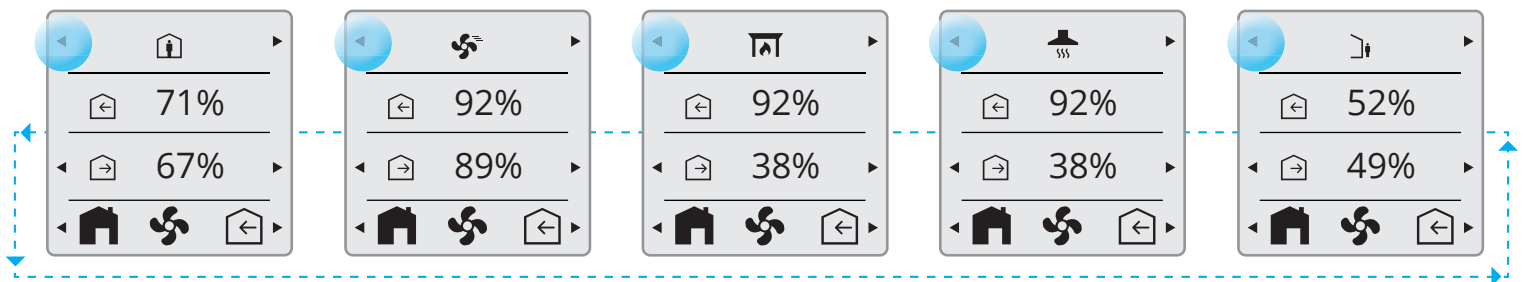

5.4. SUPPLY AIR TEMPERATURES

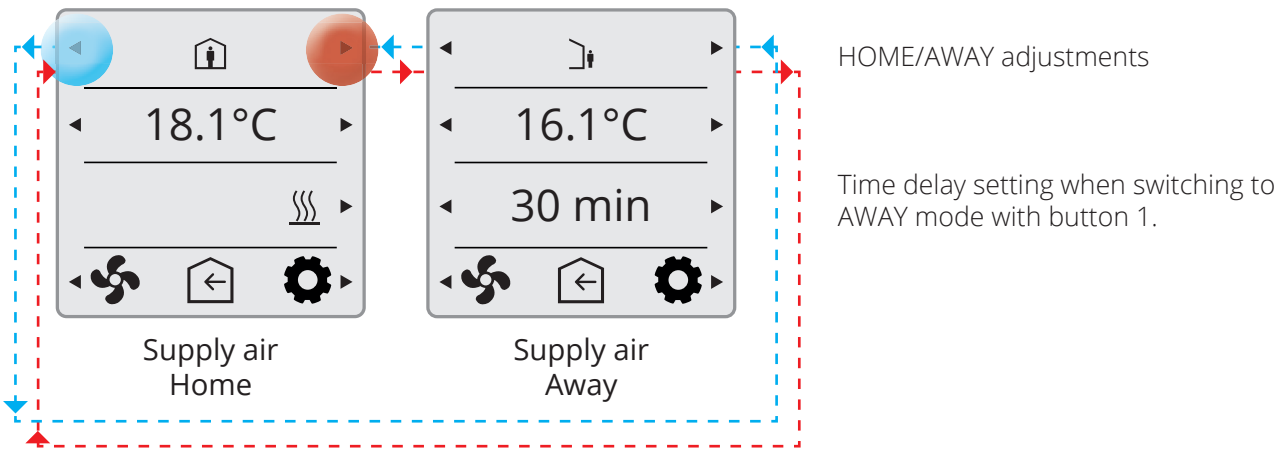
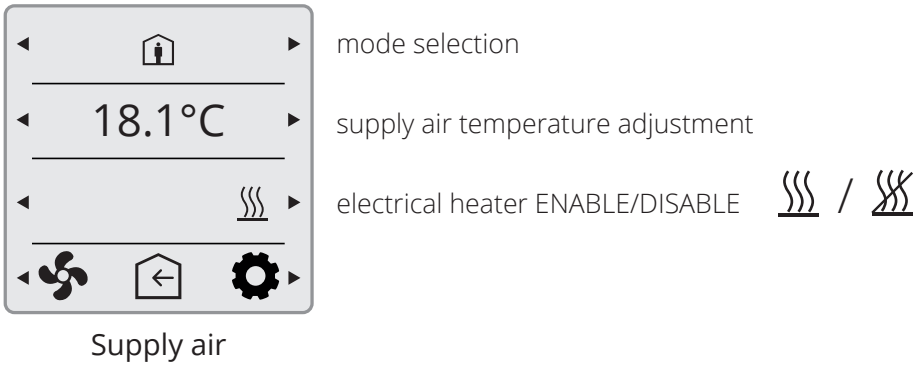

5.4.1. Home page – mode selection

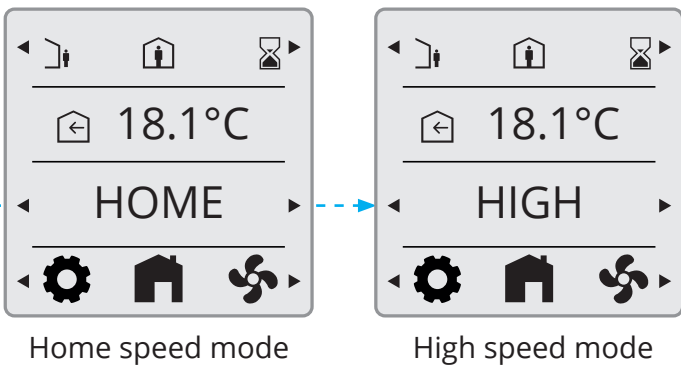

5.4.2. Home page – home/away selection

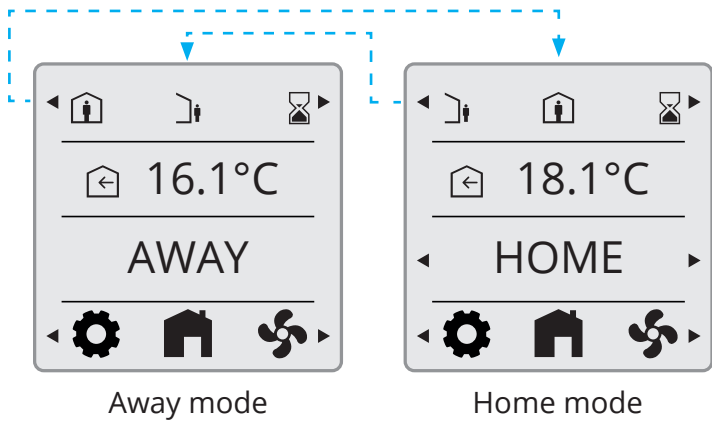

5.4.3. Home page – in scheduler mode



scheduler mode (time program)



Home speed mode



High speed mode



Away mode

5.4.4. Timer functions

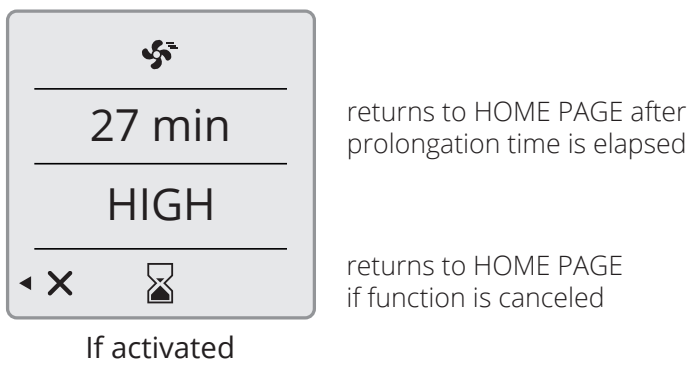
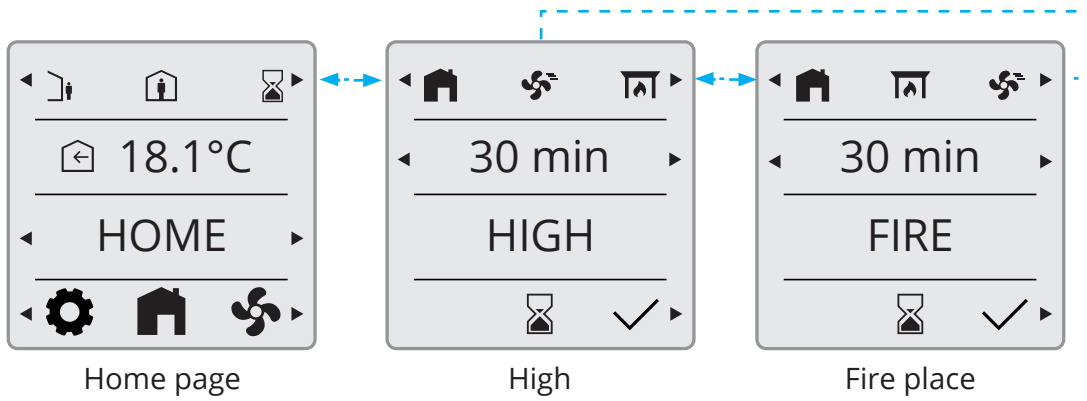

5.5. INFORMATION

Activation of cooker hood function via Digital input or wireless accesorie.

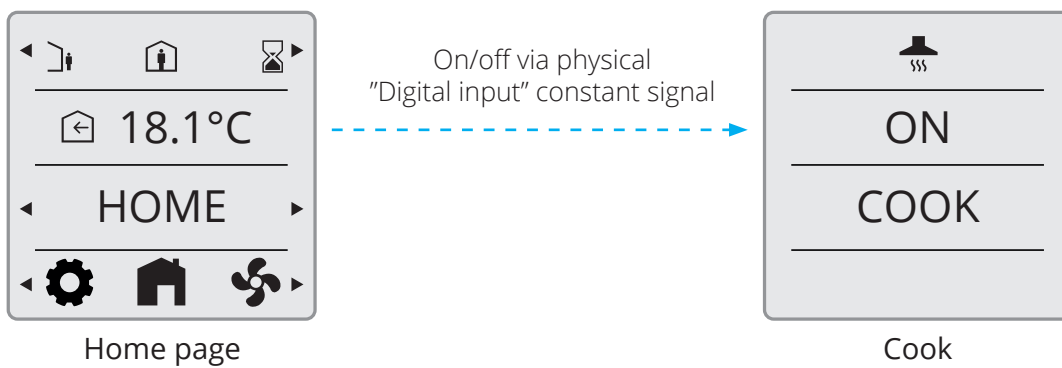

5.6. ALARM

5.6.1. Alarm mode

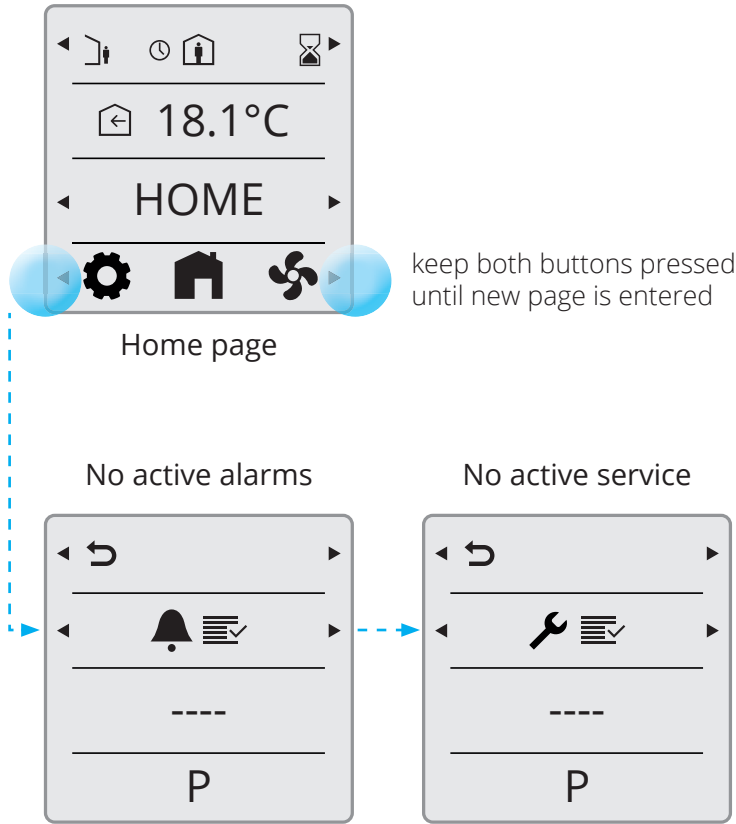

5.6.2. Filter alarm

When a filter alarm is active, a tool key is displayed and the alarm code 1020 is displayed. After the filters in the unit have been replaced, follow the procedure below to reset the alarm.

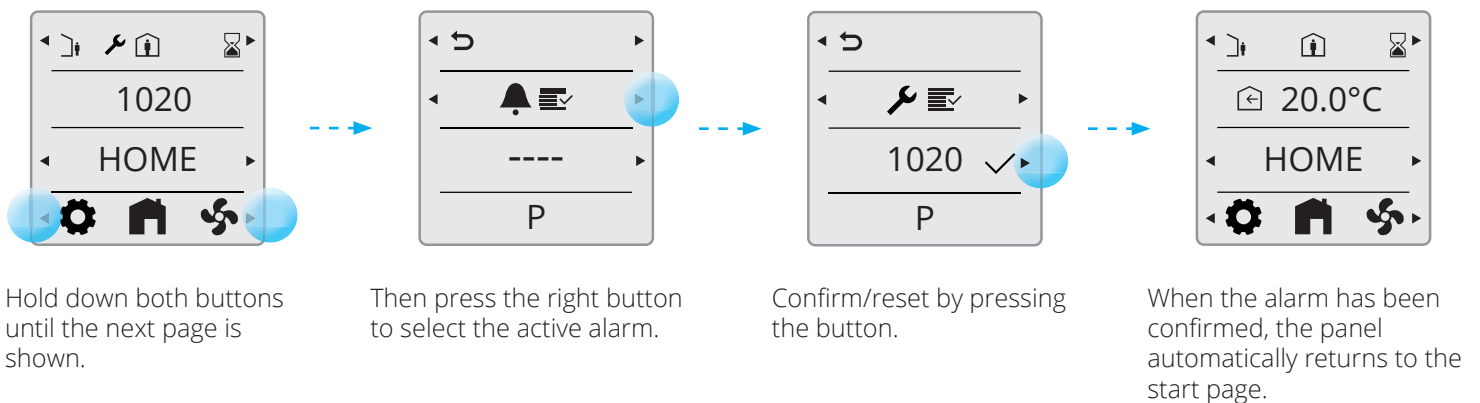

5.6.3. Reset filter timer

This function is used to reset the filter timer. The function can be used to reset the filter timer after resetting the filter alarm or it can also be used to reset the filter timer if the filter is replaced before the filter alarm has appeared.

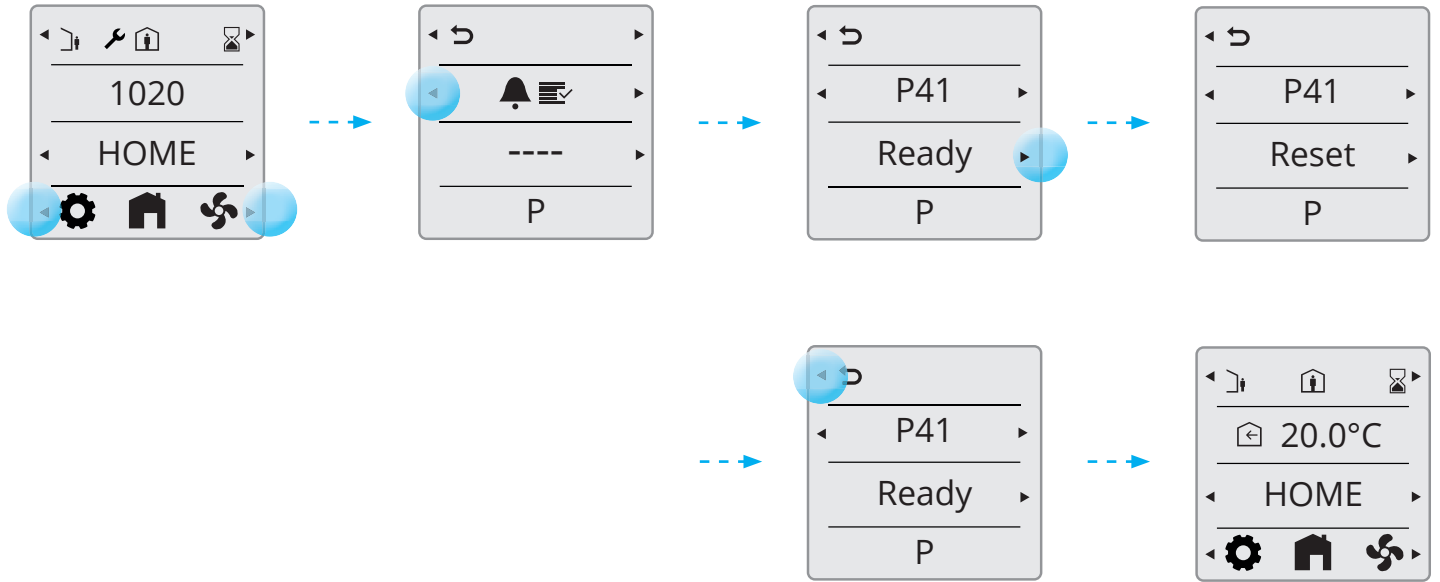

5.6.4. Filter interval

The unit has a default setting for the filter alarm interval of 6 months. If you want to adjust this, you need to connect to the unit via the FlexitGO app.

5.6.5. Acknowledge and reset A-Alarm

In case of critical A-alarms, application operation is locked until alarm is acknowledged and reset.

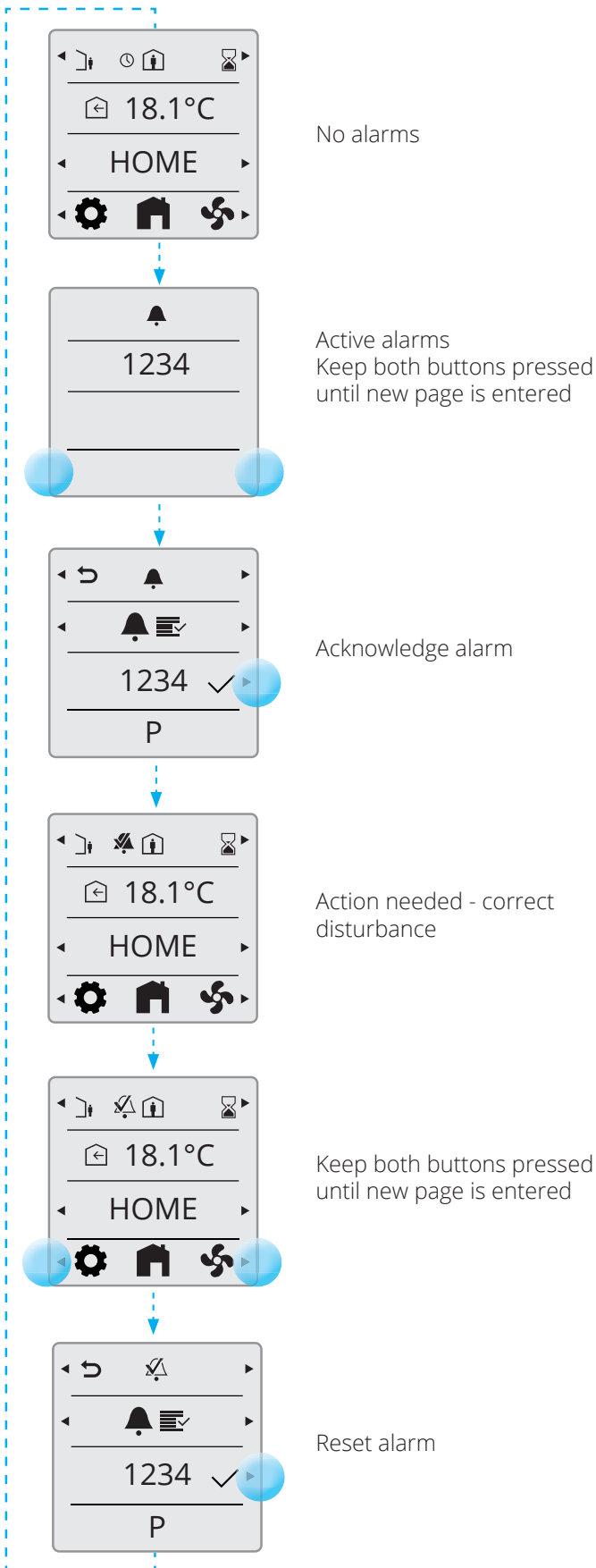

5.6.6. Acknowledge B-Alarm

Application is still operational (as much as possible), alarm has to be acknowledged.

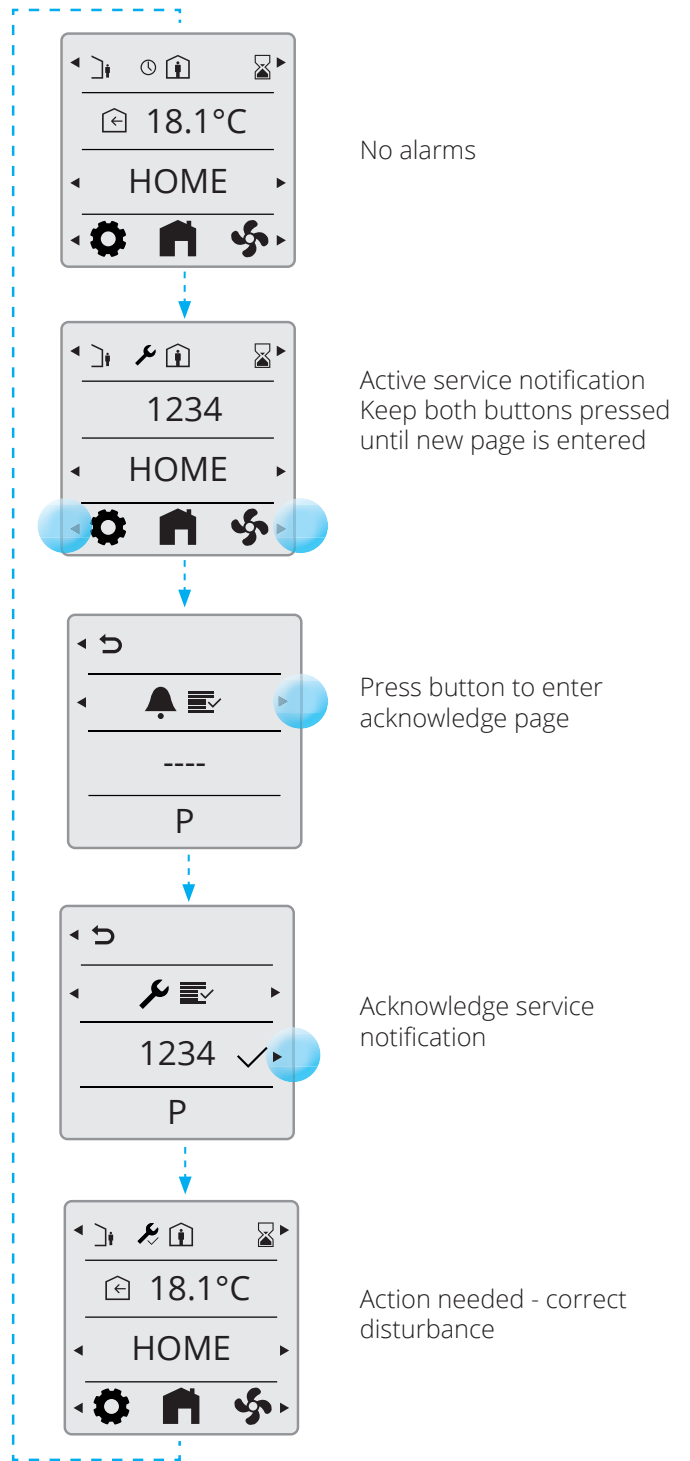

5.6.7. Alarm codes

Error code	Error source
1000...1999	Hardware related errors
2000...2999	Application related errors
3000...3999	Communication errors
9000...9999	3rd party related errors

5.6.8. Alarm codes – Hardware related errors

Code #	A/B-Alarm	Name/Text
1000...1999		Code range for - Hardware
1001	A	B1 - Supply air temperature sensor fault
1002	B	B6 - Exhaust air temperature sensor fault
1003	B	B3 - Extract air temperature sensor fault
1004	A	B4 - Outside air temperature sensor fault
1005		B5 - Frost protection temp. Heating coil sensor fault
1006	B	H1 - 0-10 V Humidity sensor fault
1007	B	M3 - Rotary heat exchanger motor stuck
1008	B	M3 - Rotary heat exchanger belt broken
1009	A	M9 - Fire damper fault
1010	A	TM1 - Supply air fan fault
1011	A	TM2 - Exhaust air fan fault
1012	B	CI-70 - Room temperature sensor on CI-70 fault
1020	B	Time to replace air filter
1022	B	B10 - HWT top sensor fault
1023	B	B11 - HWT middle sensor fault
1024		B12 - Flow temp. heating circuit sensor fault
1025		B13 - Return temp. heating circuit sensor fault
1026	B	B14 - Flow temp. After reheating coil sensor fault
1027	B	B15 - Return temp. HWT sensor fault
1028	B	B16 - HWT bottom sensor fault
1029	A	B20 - Frost protection temp. zone sensor fault
1030	B	B21 - Supply air temperature sensor fault
1032	B	Supply air pressure sensor fault
1033	B	Extract air pressure sensor fault
1034	B	P1 - Differential pressure supply air sensor fault
1035	B	P2 - Differential pressure exhaust air sensor fault
1036	A	HWT all sensor fault
1039	B	M3 - Rotary heat exchanger, motor shorted
1040	B	Low battery wireless device

5.6.9. Alarm codes – Application related errors

2000...2999	Code range for - Application & Configuration	
2001	A	X8 - Emergency off
2002	A	X8 - Smoke detector
2003	A	X8 - CO detector
2004	A	Fire alarm - B1 or B3 over max temperature
2005	B	Supply air temperature outside operating limits
2007		B5 - Heating coil frost alarm
2008	A	F15 - Heat pump reheating coil over temperature detection
2009	A	F20 - Zone 2 electric heater over temperature detection
2010	A	F10 - electric heater supply air over temperature detection
2011	A	B20 - Heating coil frost alarm zone 2
2014	A	M6, M8, M14 - Heat pump dampers stop air flow
2015	B	Heat pump A-Error present
2016	B	Heat pump outlet water over temperature (B30)
2020	B	M31 - Water pump unable to start. Restart product
2024	B	EB1 - Electric Heating, unable to control
2025	B	M3 - Rotary heat exchanger, unable to control

5.6.10. Alarm codes – Communication errors

3000...3999	Code range for - Communication	
3001	B	XCU - communication fault, heat pump
3002	A	ECU - communication fault, expansion board
3003		ECUL communication fault, expansion board
3004	B	QBM - communication fault, pressure sensor
3005	B	XCU or ECU communication fault
3006	B	CI-75 - Communication fault, wireless adapter
3007		Communication fault, wireless device

5.6.11. Alarm codes – 3rd party related errors

9000...9999	Code range for - Costumer/Non Siemens	
9001	A	B31 - Inlet water temperature sensor, heat pump
9002	A	B30 - Outlet water temperature sensor, heat pump
9003	B	B32 - Inlet air temperature sensor, heat pump
9004	B	Heat pump - Defrosting temperature sensor
9005	B	Heat pump - Discharge temperature sensor
9006	A	Heat pump - Outlet water temperature high
9007	A	Heat pump - Outlet water temperature low
9008	B	Heat pump - CO2 discharge temperature high
9009	B	Heat pump - CO2 discharge temperature low
9010	B	Heat pump - High pressure switch
9011	B	Heat pump - High air temperature defrosting
9012	B	Heat pump - Fan motor
9013	A	M31 - Water pump
9014	B	Inverter communication
9015	B	Inverter motor control
9016	B	Inverter over current
9017	B	Inverter current detection
9018	B	Inverter over voltage
9019	B	Inverter under voltage
9020	B	Inverter power supply
9021	B	Inverter voltage detection
9022	B	Inverter heatsink temperature
9023	B	Inverter overload
9024	A	Scale
9025	A	Mixing valve
9026	A	Three way valve
9027	B	Dump
9028	A	FTH

5.7. EXPERT MODE

5.7.1. Read parameter mode

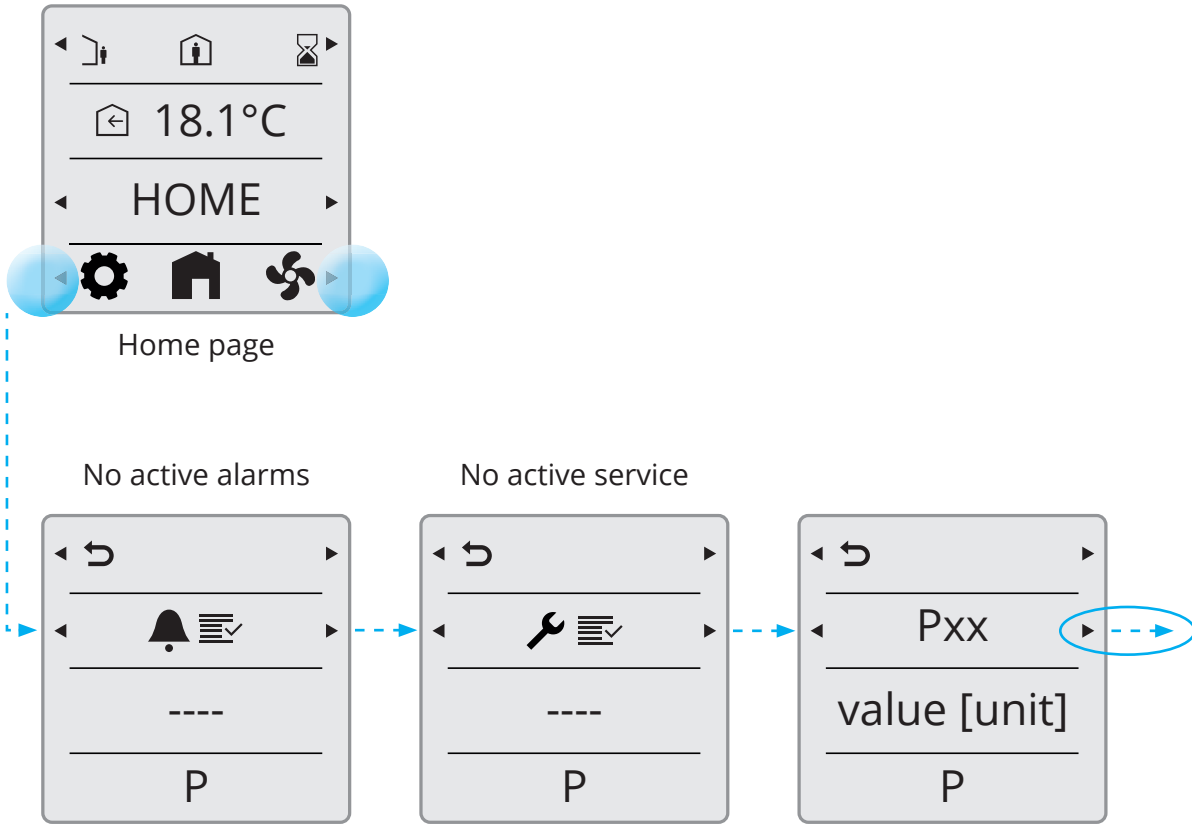

5.7.2. Parameter list

Parameter	Description	Unit	Actual value	Used in application
P00	Temperature sensor B4	°C		G4
P01	Temperature sensor B8	°C		G4
P02	Temperature sensor B5	°C		G4
P03	Temperature sensor B1	°C		G4
P04	Temperature sensor B3	°C		G4
P05	Temperature sensor B6	°C		G4
P06	Humidity sensor B6	%		G4
P07	Supply fan M1	%		G4
P08	Tacho TM1	Rpm		G4
P09	Flow sensor P1	m ³ /h or l/s		G4
P10	Pressure sensor modnus supply air	Pa		G4
P11	Supply fan M2	%		G4
P12	Tacho TM2	Rpm		G4
P13	Flow sensor	m ³ /h or l/s		G4
P14	Pressure sensor modbus extract air	Pa		G4
P15	Rotr motor RMC M3	%		G4
P16	Damper M5	open/closed		G4
P17	Bypass M4	open/closed		G4
P18	Electrical heater/Pump EV1	%		G4
P19	Thermostat BT	open/closed		G4
P20	Waterbased heater valve M10	%		G4
P21	Cooling valve CO	%		G4
P22	Cooling pump CO1	on/off		G4
P23	Fire damper M9	open/closed		G4
P24	Feedback fire damper MI4	on/off		G4
P25	Fire/smoke detector	on/off		G4
P26	Damper M6	open/closed		G4
P27	Input HIGH	on/off		G4
P28	Input HOME	on/off		G4
P29	Input AWAY	on/off		G4
P30	Input STOP	on/off		G4
P31	Input COOKER HOOD	on/off		G4
P32	Input FIRE PLACE	on/off		G4
P33	Input HOME/AWAY	on/off		G4
P34	Input Air quality	ppm		G4
P35	Input Humidity	%RH		G4
P36	Input Radon	Bq/m ³		G4
P37	Backlight level	-		
P38	CI-1 temperature value shift	K		
P39	Unit selection: Celcius – Fahrenheit	-		
P40	Unit selection: m ³ /h or l/s	-		

6. Technical data

6.1. MECHANICAL DIMENSIONS

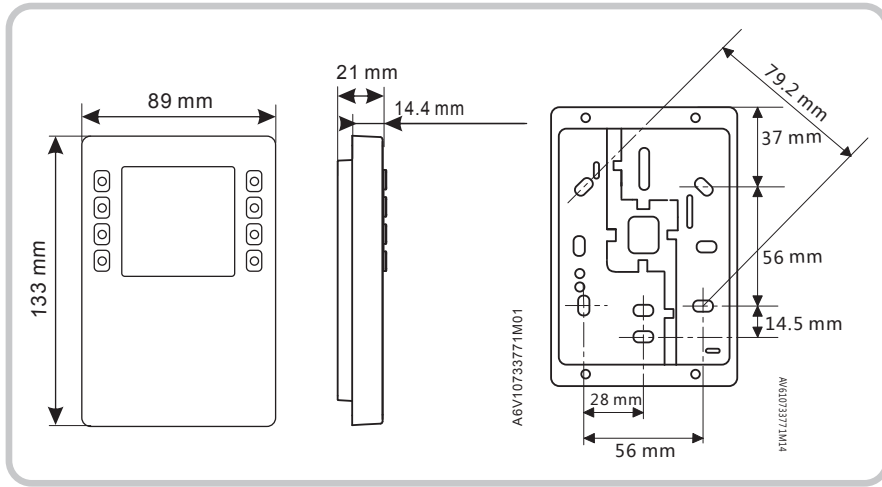

6.2. SPECIFICATION

General data

Color	Signal white (RAL9003)
Weight	150g

Power supply*

Operating voltage	KNX / PL-Link DC 21...30 V
Max power consumption	7...10 mA

Interfaces

Type of port between room automation station and room operator unit	KNX / PL-Link
Baud rate	9.6 kbps
Protocol	KNX PL-LINK
Standard KNX plug	Wire diameter 0.8 mm, max. 1.0 mm
Cable type	2-core twisted pair, stranded, solid
Single cable length (from room automation station to room operator unit)	<1000 m
Section	0,5...1,5 mm ²
Bus line polarity	PL+,PL-
Bus terminating resistor	not required

Sensor data

Temperature Sensor	Measuring element	NTC resistance sensor
	Measuring range	0..50 °C
	Measuring accuracy (5...30°C)	±0.8 °C
	Measuring accuracy (25°C)	±0.5 °C

Ambient conditions and protection classification

Housing Protection	IP30
--------------------	------

Protection standard as per EN 60529	IP33 for surface part
Insulation protection class	Class III
Climatic ambient conditions:	
Normal operation	Environmental Conditions: Class 3K5
	Temperature 0...50 °C (0... 122 °F)
	Air humidity <85% rh.
Transport	Environmental Conditions: Class 2K3
	Temperature -25...70 °C (-4... 158 °F)
	Air humidity <95% rh.
Mechanical ambient conditions:	
Normal operation	Class 3M2
Transport	Class 2M2

Standards, directives and approvals	
EU conformity (CE)	
RCM conformity to EMC emission standard	
CSA Compliance	CSA C22.2M205
IC Compliance	CAN ICE-3(B)/NMB-3(B)
UL Compliance	UL916, UL873/UL60730
FCC Compliance	Part 15 of the FCC rules. Operation is subject to the following two conditions: 1) the device may not cause harmful interference, and 2) the device must accept any interference received, including interference that may cause undesired operation.

6.3. MAINTENANCE

The device can be cleaned with off-the shelf, solvent-free cleaning agents.

Do not use mechanical aids (rough sponge or similar materials) – only a soft, damp cloth.

6.4. DISPOSAL



The device is considered an electronics device for disposal in terms of European Directive 2012/19/EU and may not be disposed of as domestic garbage.

- Dispose of the device through channels provided for this purpose.
- Comply with all local and currently applicable laws and regulations.



Flexit AS, Televeien 15, N-1870 Ørje
www.flexit.no