



Nordic CL 2/3/4

ART.NO. 116670, 116671, 116672,

EN

INSTALLATION INSTRUCTIONS

Water heating element

Contents

1. Water battery intended for heating of ventilation air.....	4
2. System drawing	5
3. Technical data.....	6
3.1. General.....	6
4. Capacity and sound data, CL2.....	7
4.1. Supply air side, CL2.....	7
4.2. Extract air side, CL2	7
5. Capacity and sound data, CL3.....	8
5.1. Supply air side, CL3.....	8
5.2. Extract air side, CL3	8
6. Capacity and sound data, CL4.....	9
6.1. Supply air side, CL4.....	9
6.2. Extract air side, CL4	9
7. Plumbing.....	10
7.1. Location of the water heating element	10
8. Dimensions	13
9. Electrical work.....	15
10. Return water sensor (B5).....	19
11. Wiring diagram	19
12. Configuration	21
13. Maintenance	22
14. Accessories.....	23
15. Frost safety function in the ventilation system control system.....	24



All electrical connections must be carried out by qualified electricians.

*Our products are subject to continuous development and we therefore reserve the right to make changes.
We also disclaim liability for any printing errors that may occur.*

1. Water battery intended for heating of ventilation air

Content water battery









- Battery
- Cable set
- B5 return water sensor, with isolation and cable ties.
- Long NTC sensor (B1) for installation after the channel battery
- Wago clips
- Cable ties

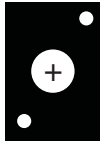

Accessories:

- Shunt valve
- Shunt valve motor
- Air damper
- Circulationspump (not in Flexits sortiment)

See complete overview with art.no. i chap.14. Accessories on page 23.

<p>Symbols</p>	 Pump	 Non-return valve
 Shuntvalve with motor	 Water battery	 Grille
 Air damper with spring loaded closing	 Temperature sensor	 Return water sensor
 Commissioning valve		

2. System drawing

The ventilation system must be connected to a damper with motor and spring loaded closing. We recommend dampers on both outdoor air and exhaust air, minimum on outdoor air. This prevents freezing when failure on the heat source/supply failure.

The water system shall be provided with a return water sensor (B5) and a circulation pump to maintain freezing protection function. Shunt valve regulates heat to the supply air.

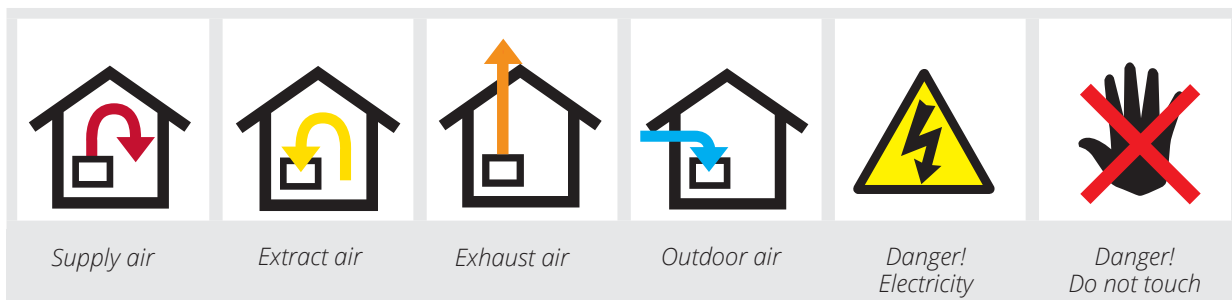
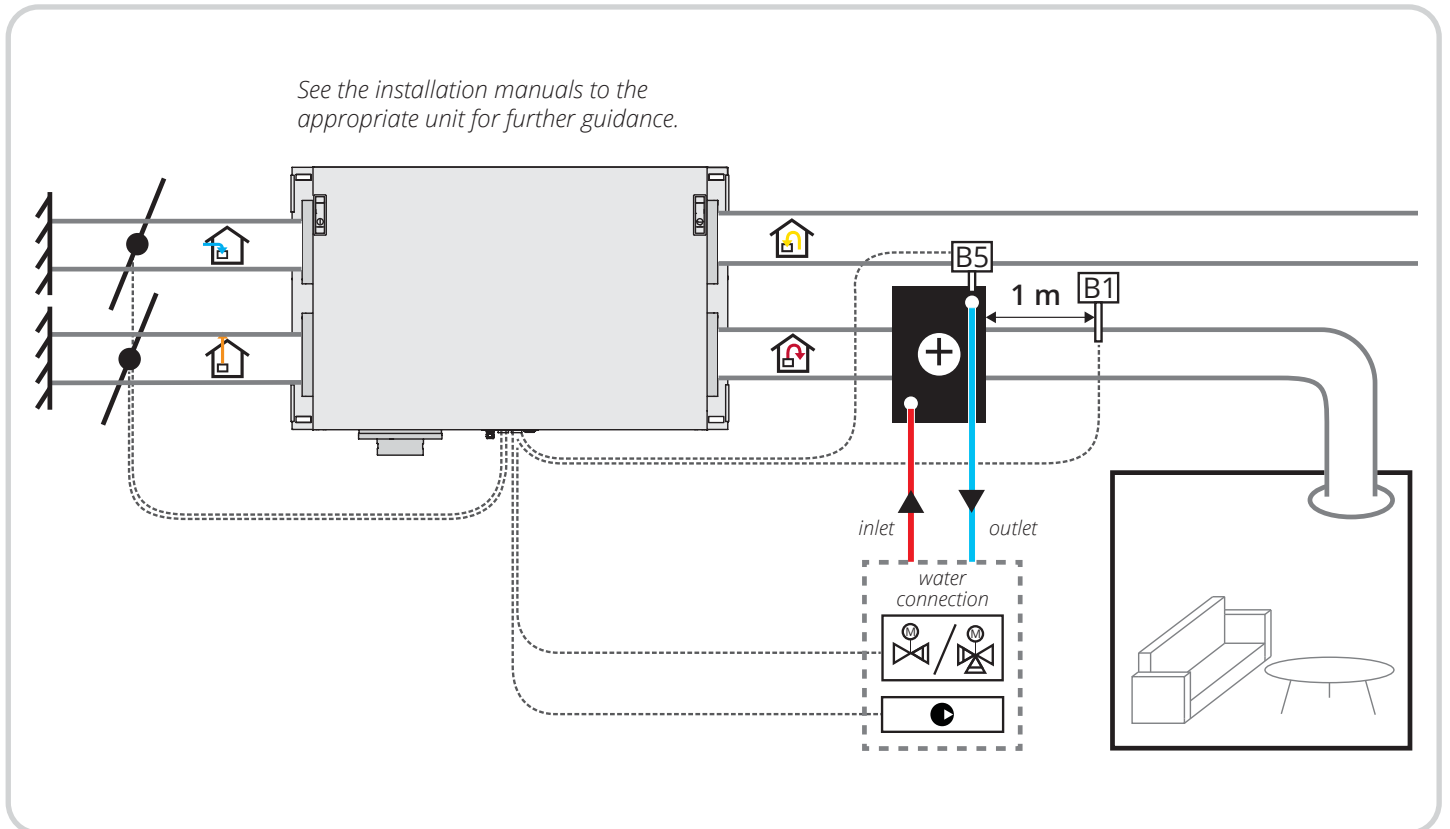

3. Technical data

3.1. GENERAL

Dimension data from calculation of table.
 Outside temperature -25 °C
 Inside temperature + 20 °C

For each shunt valve there is a KV_s -value
 (capacity value in m^3/h):

K_v - Valve coefficient given as water flow in m^3/h , with
 a pressure drop over a fully opened valve with 1 bar
 (100kPa) calculated.

$$m^3/h K_v = 36 \frac{q (l/s)}{\sqrt{\Delta P (kPa)}}$$



To obtain correct values, employ the
 Flexit calculation application.

For more information, see www.flexit.com

For water heating elements, constant flow is preferable
 (see example connection A and B). Then there is always
 circulation in the battery and it avoids that stagnant
 water freezes at low temperature. It has a circulating
 pump in the battery circuit.

Since we do not have this information about the facilities
 we have chosen to provide the choice of 3-way valve with
 valve authority at a given pressure drop. The pressure
 drop is chosen as high as possible but with a about 50%
 valve authority. Guide for 3-way valves may therefore be
 seen as examples that apply under given conditions. It is
 therefore important that the plumber check the choice
 of shunt valves and make the necessary adjustment of
 the current facility.

The valve should be selected so the minimum is 50%
 valve authority. This is important for the valve to give any
 effect when it regulates.

Valve authority: The pressure drop across the valve
 relative to both the pressure drop across the valve +
 pressure drop in the flow circuit.

4. Capacity and sound data, CL2

4.1. SUPPLY AIR SIDE, CL2

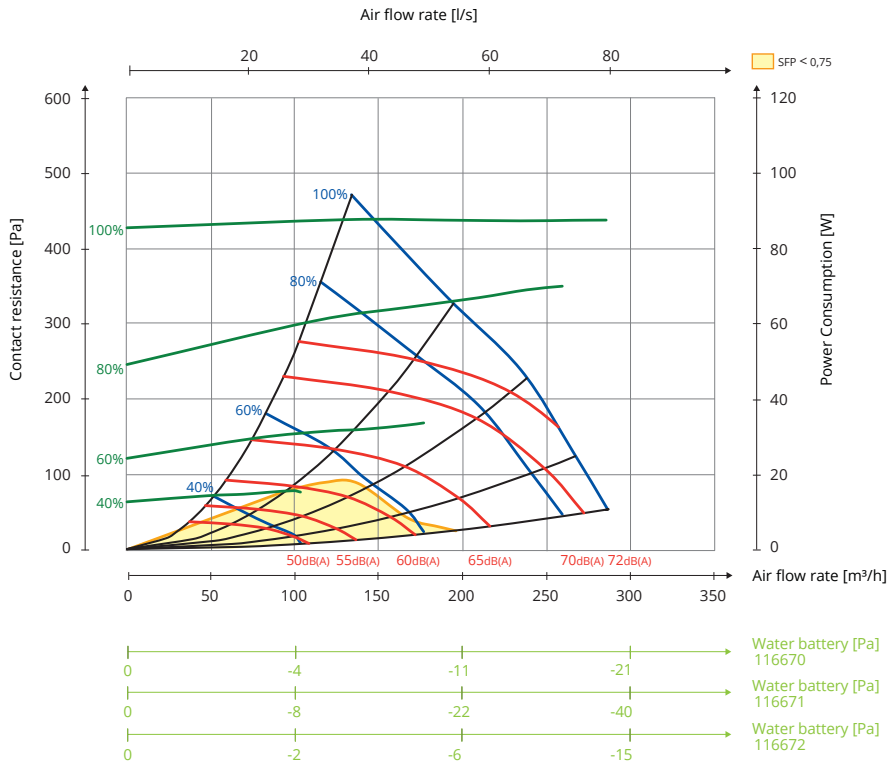

4.2. EXTRACT AIR SIDE, CL2

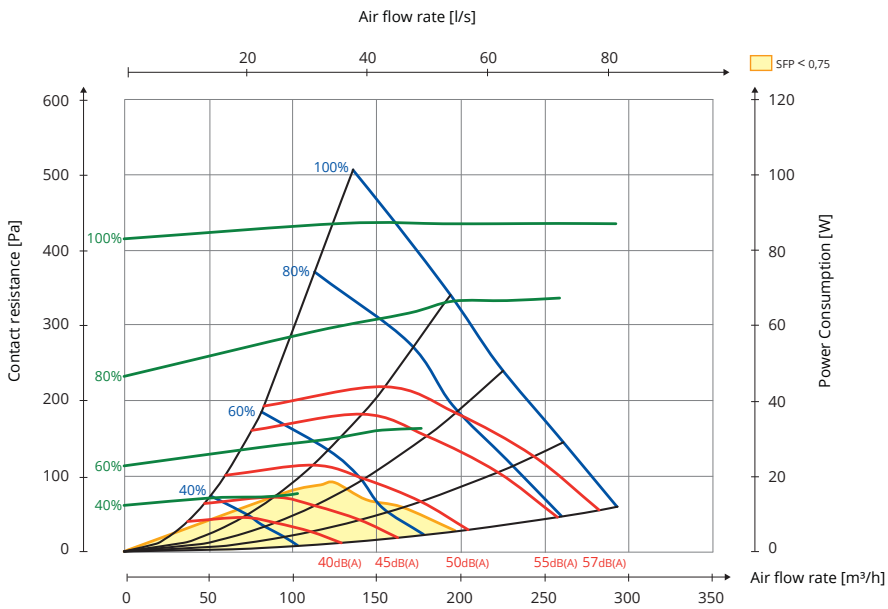

Colour	Graph key
█	Air capacity at various capacity settings in %
█	Supply air fan power output at various capacity settings
█	Sound power level LwA
█	Pressure loss using a water battery

5. Capacity and sound data, CL3

5.1. SUPPLY AIR SIDE, CL3

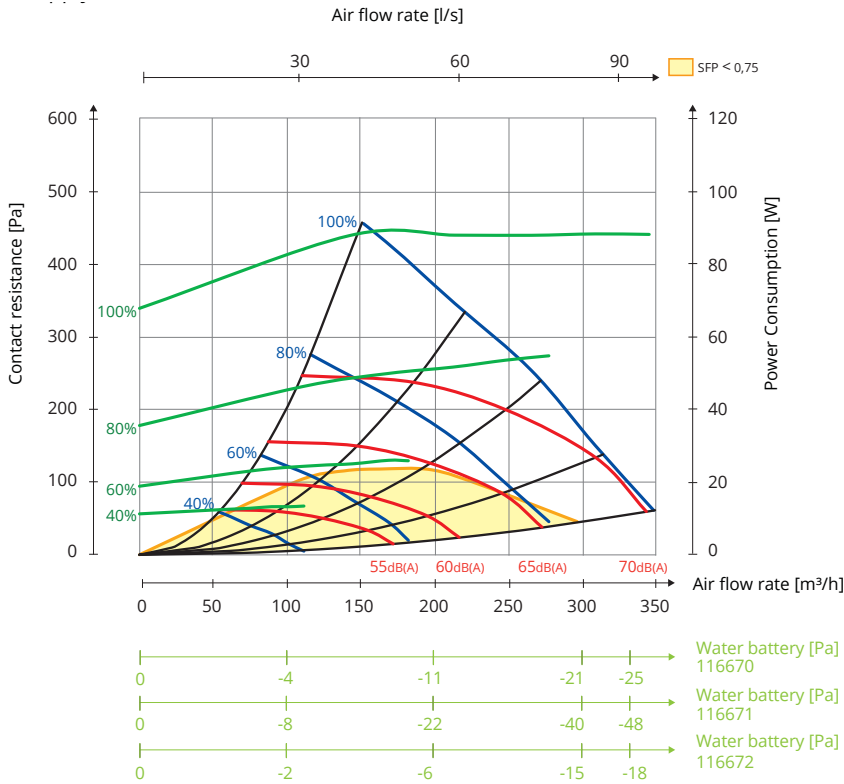

5.2. EXTRACT AIR SIDE, CL3

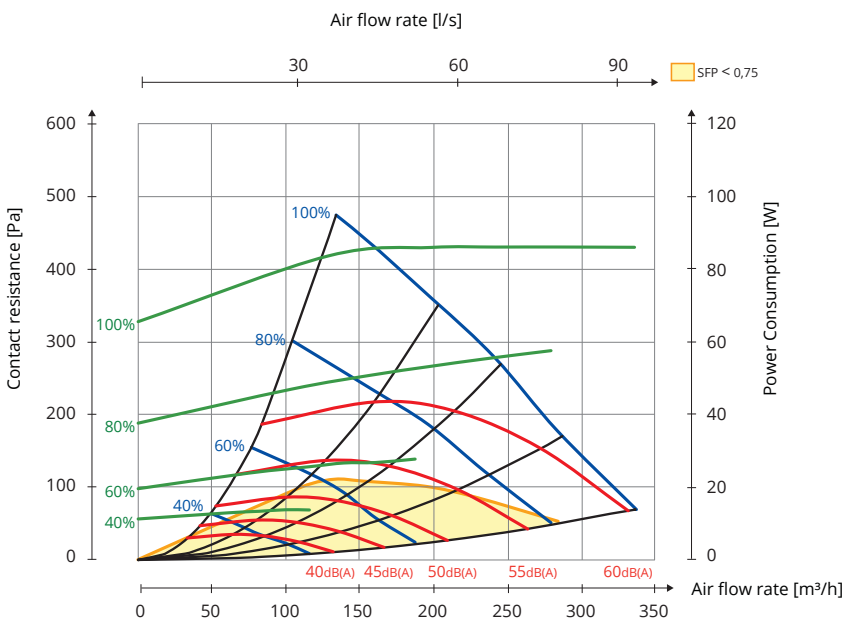

Colour	Graph key
Blue	Air capacity at various capacity settings in %
Green	Supply air fan power output at various capacity settings
Red	Sound power level LwA
Light Green	Pressure loss using a water battery

6. Capacity and sound data, CL4

6.1. SUPPLY AIR SIDE, CL4

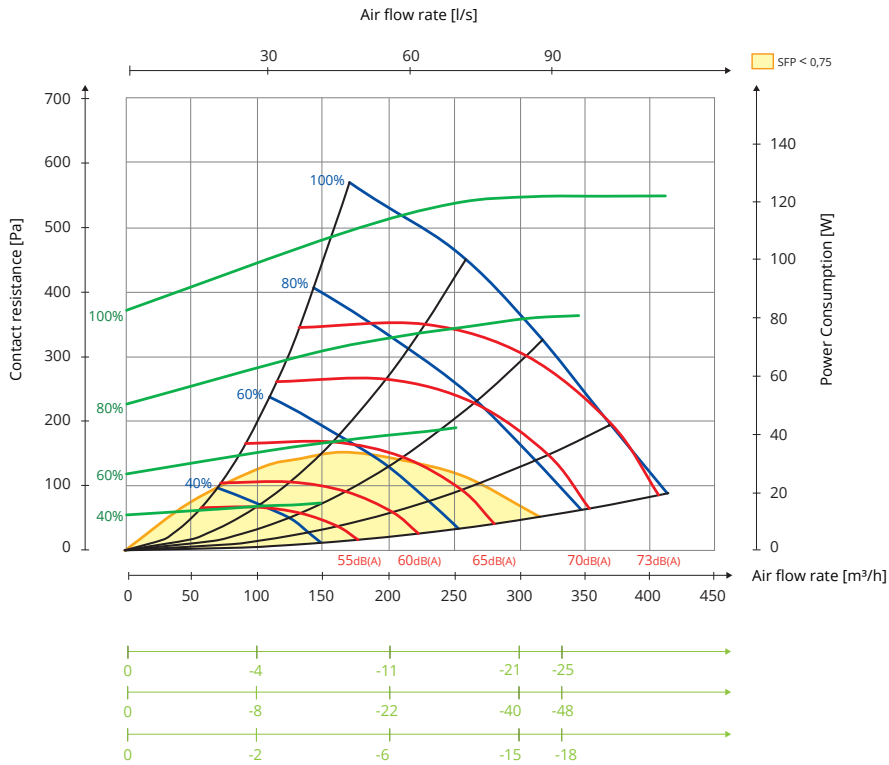

6.2. EXTRACT AIR SIDE, CL4

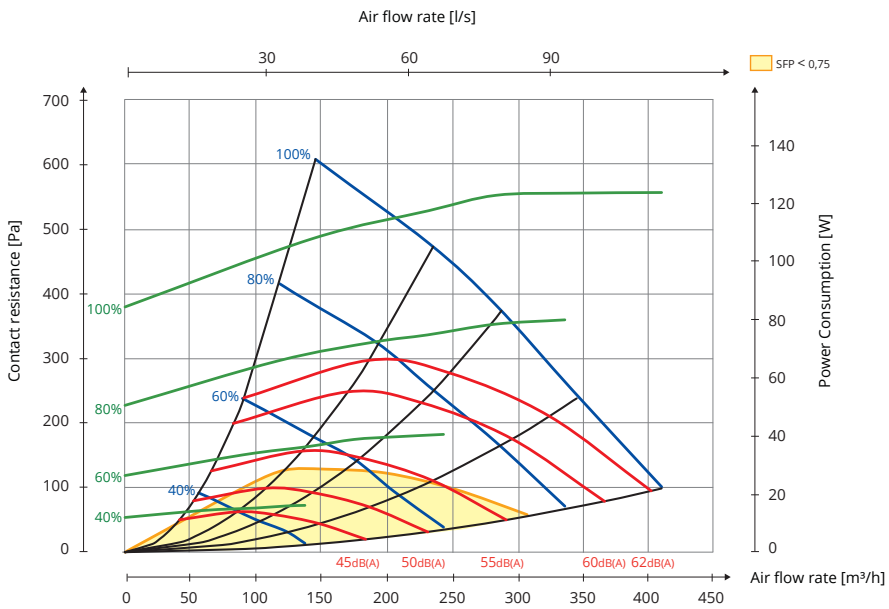

Colour	Graph key
█	Air capacity at various capacity settings in %
█	Supply air fan power output at various capacity settings
█	Sound power level LwA
█	Pressure loss using a water battery

7. Plumbing

All plumbing must be carried out by an authorised plumber.

Place the unit/water battery near a gully to prevent damage in case of a water leakage.

7.1. LOCATION OF THE WATER HEATING ELEMENT

The duct battery is mounted after the ventilation unit on to the supply air duct. Follow these directions to position the battery correct (See fig. 1 and 2). The element must be placed with a good distance to potential duct bends, to avoid uneven air flow above the element.

Counter flow:

Heating batteries should always be connected so that water runs counterflow relative to the airflow (the water shall move towards the air) see product labeling. This is important to achieve the correct function.

AIR HANDLING UNIT:



WARNING! Before commencing installation, pull out the mains plug and wait 2 mins before opening the door.



NB! Please consider service accessibility before commencing installation.

Fig. 1

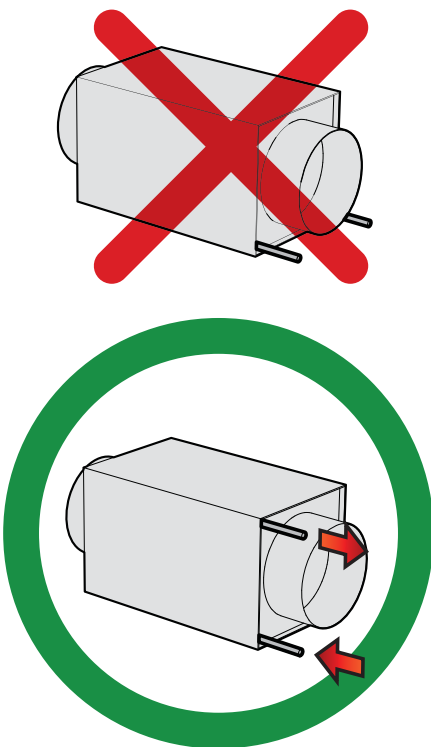

When installing horizontally, incoming water shall be connected to the lower pipe. Do not place the element so that both pipes positions at the bottom, or at the top.

Fig. 2

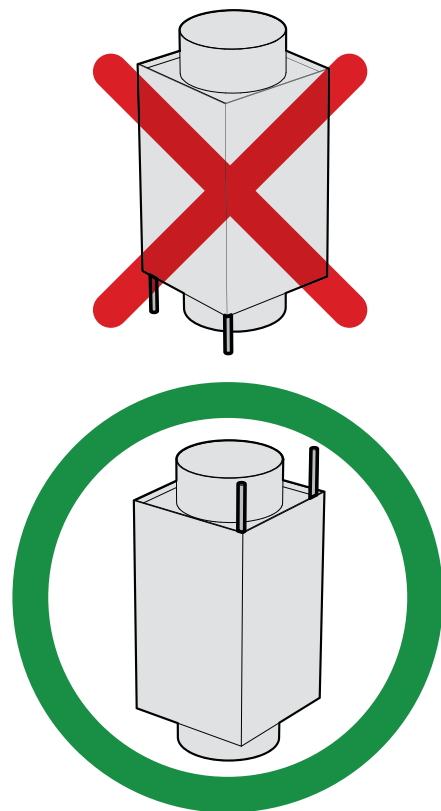

When installing vertically, the connection pipes for water, must face upwards.

Venting

Remember to connect the T piece for venting, at the highest point in the circuit.

Frost risk

A spring loaded shutting damper must be connected to the outdoor and exhaust air duct. This prevents cold air current on the element upon system outage, which in turn might lead to frost damages.



If antifreeze solution is not used, the element must be placed in a heated room to avoid frost damage.



The system should be tested for correct function before use.



The water heating element should be placed in a room with drainage.

Connections

The water supply must be at the bottom of the water battery, the return must be on the top. See product labeling.

Place the shuntvalve as close as possible to the water battery (preferably max 2m). Note that many valve motors can operate in both directions, and that this can be controlled on the motor itself. Adjust it so that the valve opens on a rising 0-10V signal.

Upon connecting to the pipe system, the following points must be considered:

- The connection pipes must not be subjected to torsion or bending.
- Ensure that neither expansion forces in the system nor the weight of the system itself strain the connections.
- Check the system for potential leakage after filling it with water.

Example

Connection A - Norwegian connection

Shunt with 3-way valve which works with constant flow in primary and secondary circuit. The 3-way valve is mounted on the secondary side and does not affect the primary system. Primary flow might be higher than the secondary flow. This connection assumes that the temperature in primary and secondary circuit is the same. The connection is common for air battery in Norway.

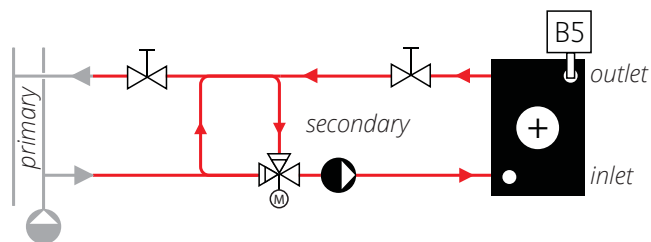

The K_v value should be chosen so that it gets min. 50% valve authority.

Example

Connection B - Swedish connection

Shunt with 3-way valve which works with constant flow in primary and secondary circuit. You may have higher flow in the secondary circuit and a small temperature loss. This connection is often applied in heating systems with their own heating source. (Ex. boiler system)

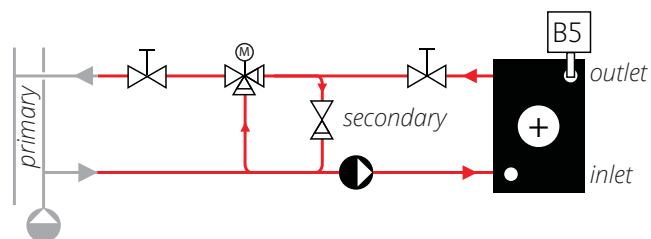

The K_v value should be chosen so that it gets min. 50% valve authority.

Example

Connection C - 2-way connection

Shunt with 2-way valve which works with variable flow in primary circuit and constant flow in secondary circuit. Use the connection when you want variable flow in primary circuit and high temperature loss. The connection is often used with long-distance heating when you want low return temperature.

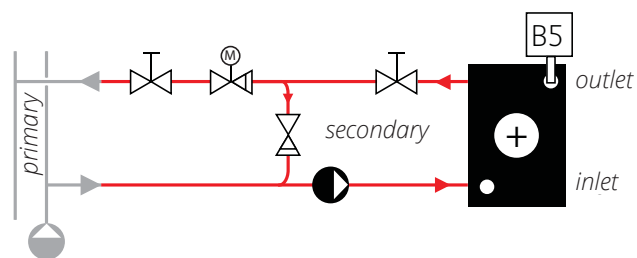

The K_v value should be chosen so that it gets min. 50% valve authority.

8. Dimensions

Type A, Ø160, art.no. 116670

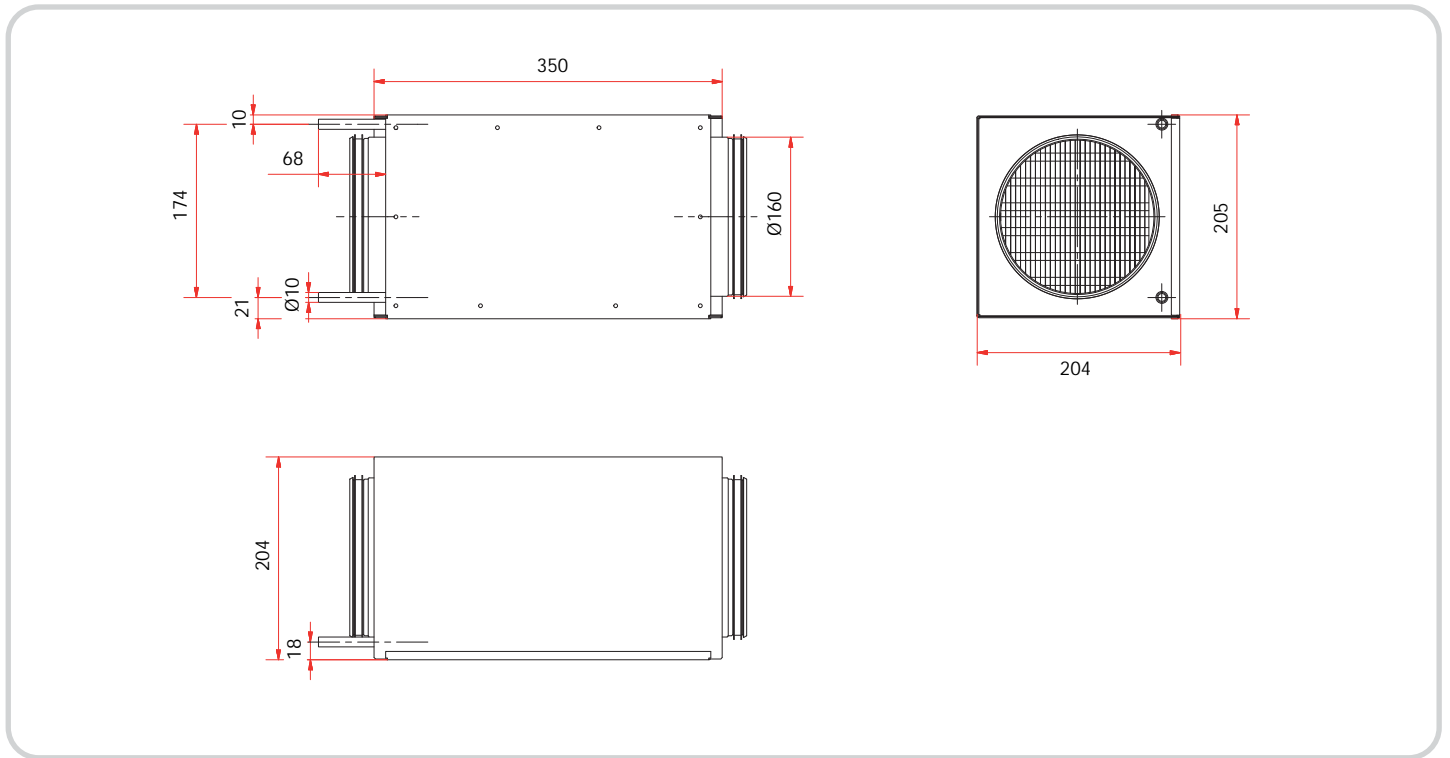

Type B, Ø160, art.no. 116671

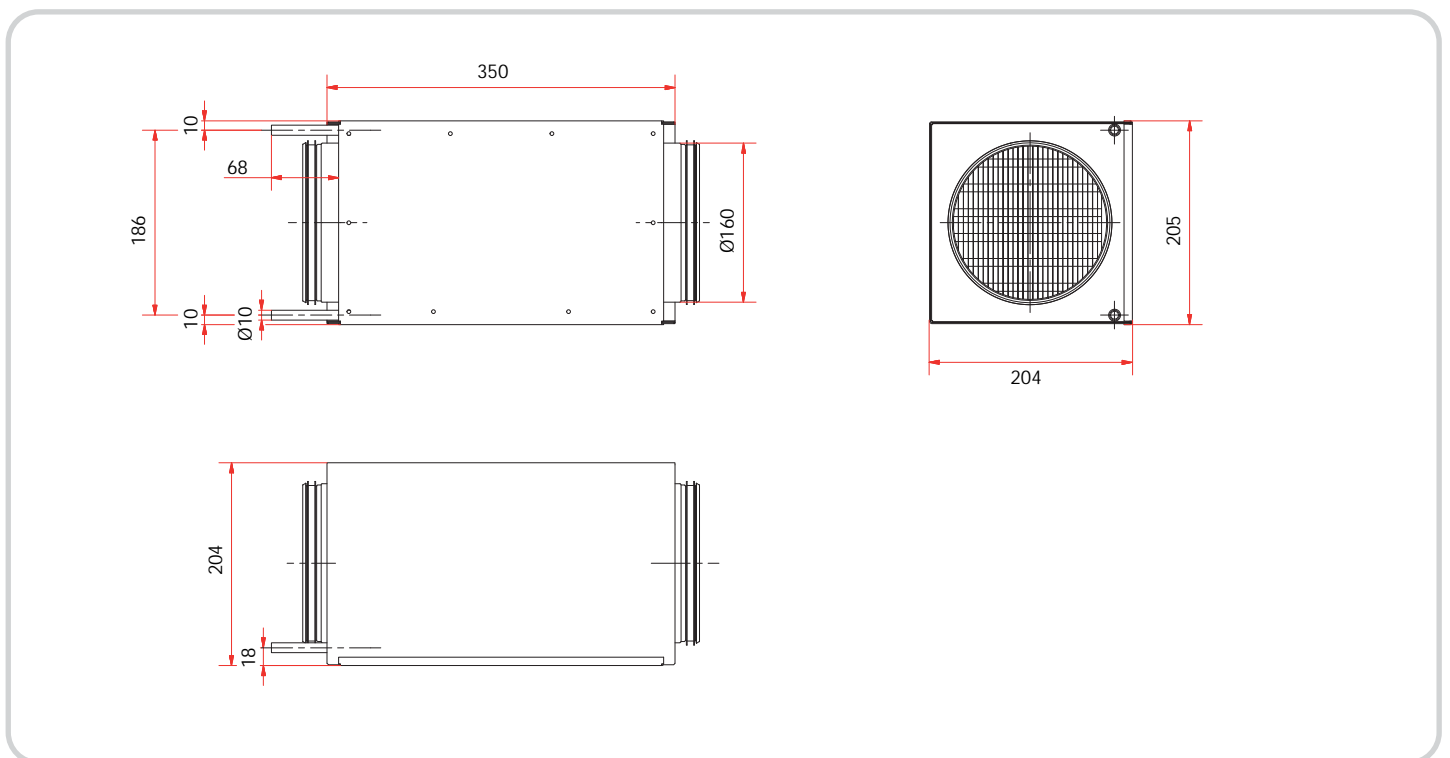

Type C, Ø160, art.no. 116672

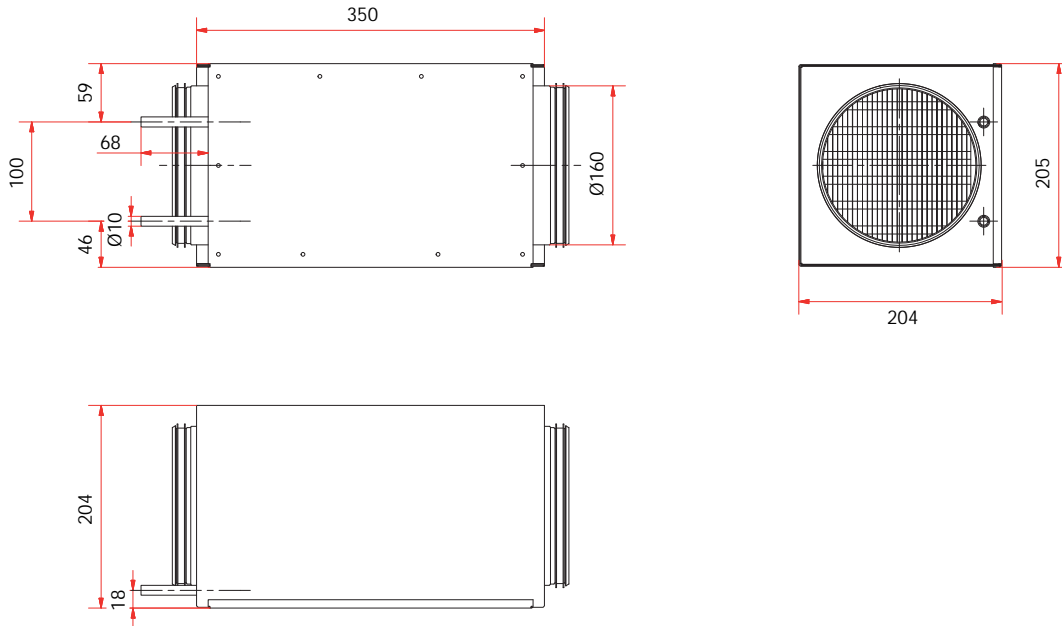

9. Electrical work



All electrical connections must be carried out by qualified electricians.

1

Remove the cover of the electrical compartment.

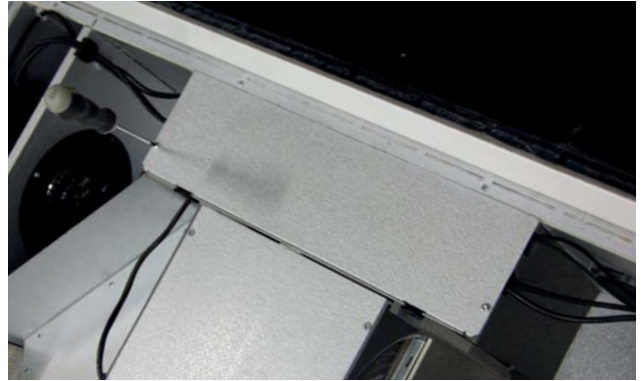

2

Cut off the cable ties and disconnect the electric battery contacts (**NB: 2 contacts**).

NB: The electric battery must be disconnected because the same outputs are used by the pump in the water battery configuration.



3

To avoid short-circuit, the protective sleeves on the electric battery contacts (2) must be fixed with cable ties.



4

Disconnect the fire thermostat (F10).
(NB: 2 contacts)

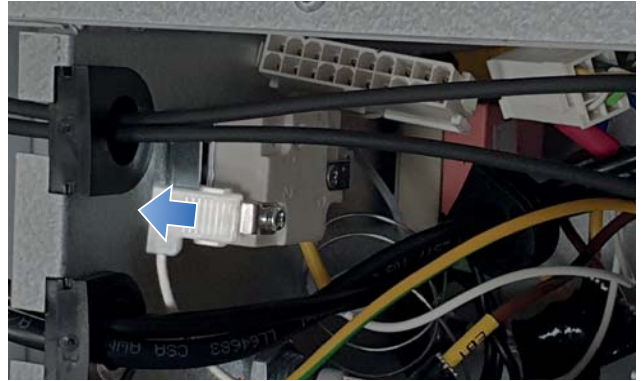

5

Locate the temperature sensor (B1) and cut it off.
TIP: Follow the sensor from the supply air fan and into the electrical compartment.

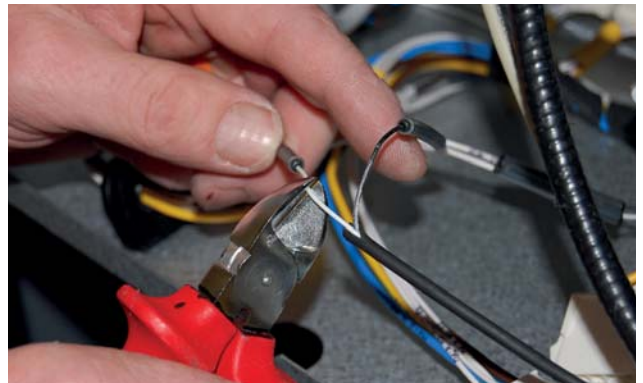

6

Join the enclosed NTC sensor and the temperature sensor (B1) by fitting a Wago clip in the transition between the sensors.

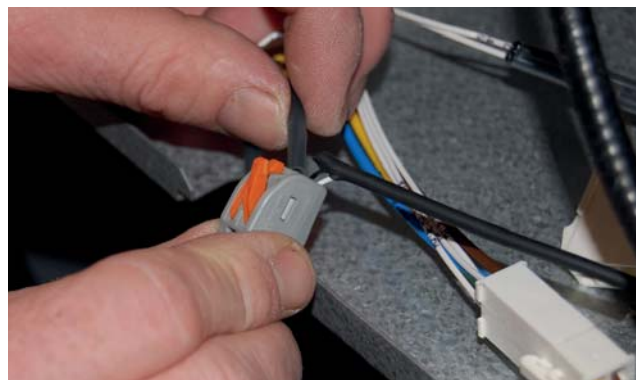

7

Connect all cables to the terminal block before it is pressed onto the wall of the electrical compartment.

**8**

Connect the contacts in the electrical compartment.

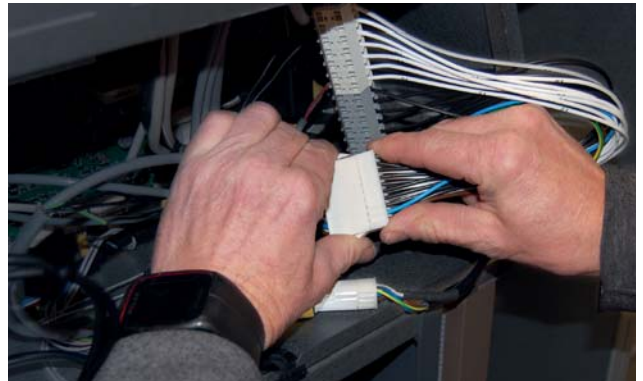

4



Temperature sensor B1 must be placed after the heating element.

Place the sensor in the supply air duct (refer to label on top of the ventilation unit), approximately 1m away from the the heating element. The sensor is in the electrical compartment.

Drill a 7mm hole in the duct, for the sensor. Enter the sensor into the hole, seal the hole and attach the wire to the duct using tape.

For connection info on return water sensor (B5), valve motor and shutting damper, refer to the wiring diagram.



5

Use the unit's cable bushings for connecting external components.

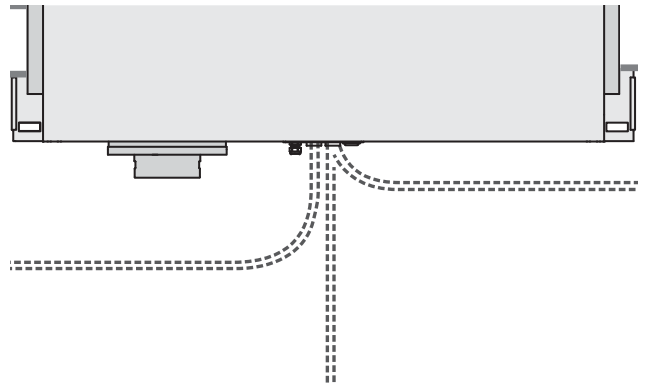

10. Return water sensor (B5)



To prevent the element from freezing, a sensor (B5) must be attached to the water pipe for outgoing water.

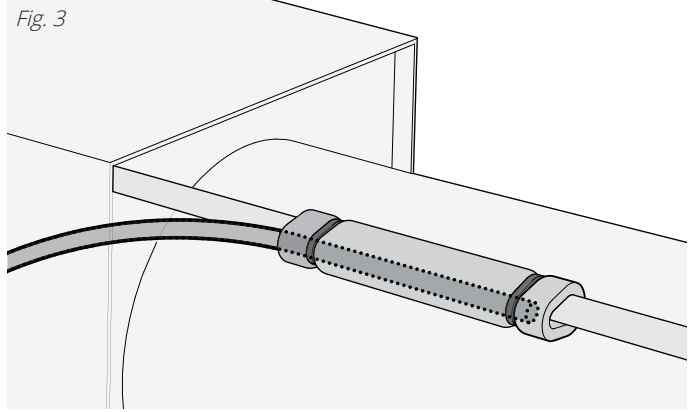

Attach the sensor with isolation and strips (see fig. 3).

11. Wiring diagram

NB! Block numbers are not in order in the examples.

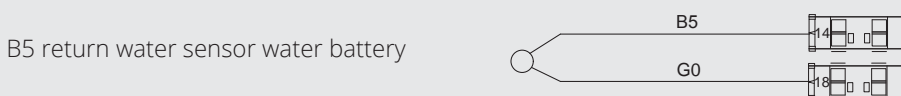
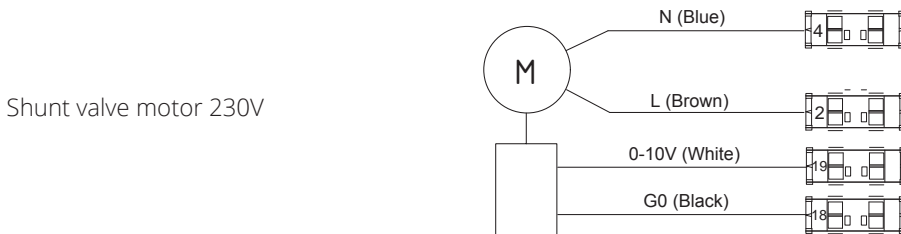
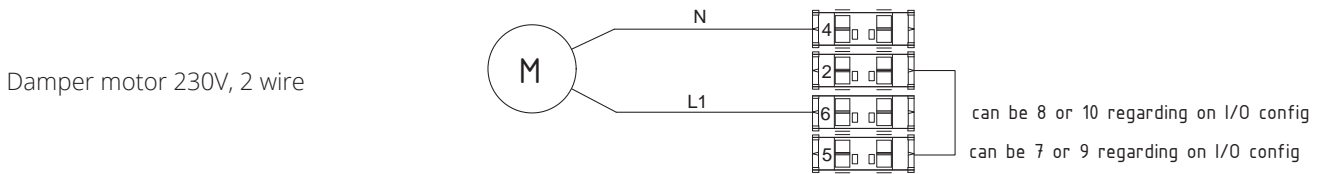

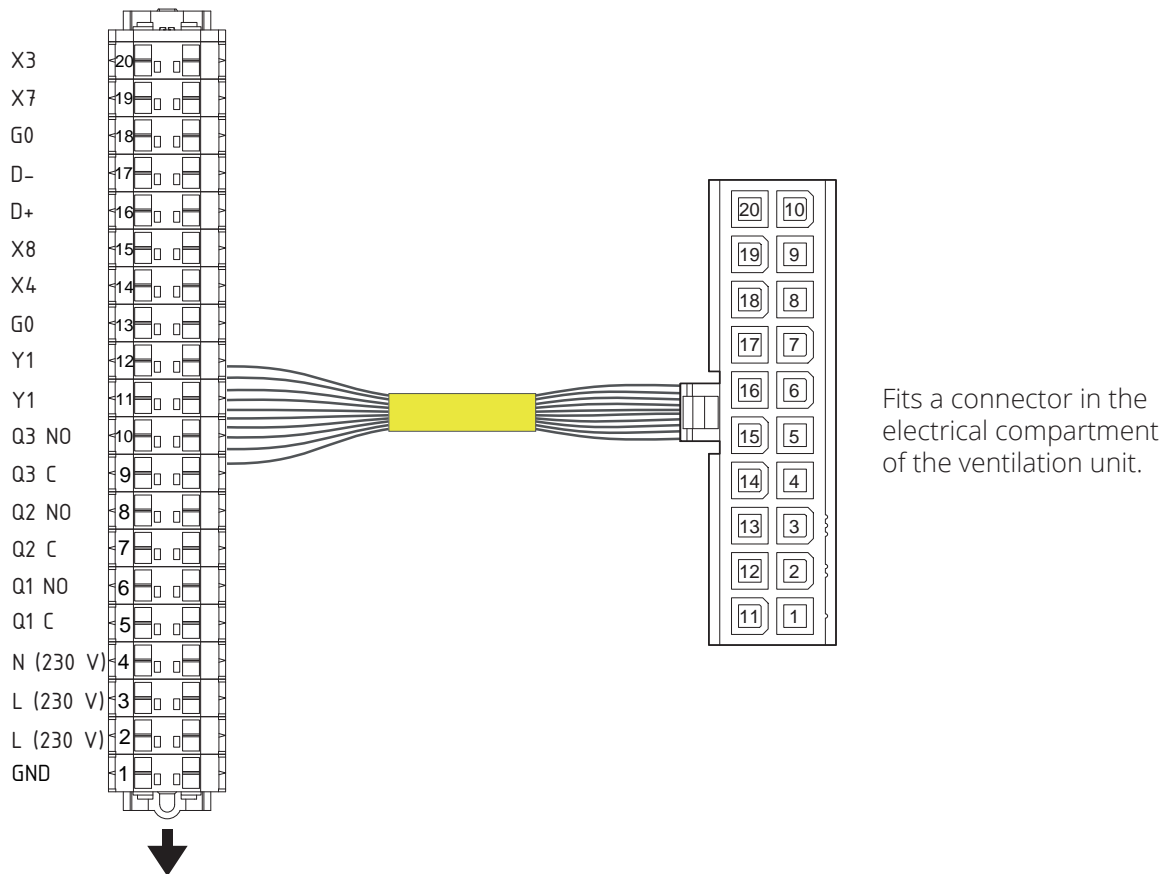

1	GND	PE
2	L (230 V)	L 230 V
3	L (230 V)	L 230 V
4	N (230 V)	N 230V
5	Q1 C**	Supply digital output 1
6	Q1 NO*	Digital output 1 normally open The following choices can be made: None <u>Outside air damper</u> Fire damper Common alarm and maintenance indication Alarm indication Maintenance indication Operation indication Bypass damper Cooling pump
7	Q2 C**	Supply digital output 2
8	Q2 NO*	Digital output 2 normally open The following choices can be made: None Outside air damper Fire damper <u>Common alarm and maintenance indication</u> Alarm indication Maintenance indication Operation indication Bypass damper Cooling pump
9	Q3 C**	Supply digital output 3
10	Q3 NO*	Digital output 3 normally open The following choices can be made: None Outside air damper Fire damper Common alarm and maintenance indication Alarm indication Maintenance indication Operation indication Bypass damper Cooling pump

11	Y1*	Digital output Y1 (230 V) The following choices can be made: None Electrical heater <u>Pump water heater</u>
12	Y1*	Digital output Y1 (230 V) The following choices can be made: None Electrical heater <u>Pump water heater</u>
13	G0	Signal ground
14	X4*	Digital or analog input The following choices can be made: Ingen Thermostat overheating Return water temperature
15	X8*	Digital input X8 The following choices can be made: None Home <u>Away</u> Emergency off CO detector Smoke detector - extract Smoke detector - supply Smoke detector - off Smoke detector - max Fire damper feedback
16	D+	Modbus slave D+
17	D-	Modbus slave D-
18	G0	Signal ground
19	X7*	Analog output 0-10 V The following choices can be made: None <u>0-10V Water heater valve</u> 0-10V Water cooling valve
20	X3*	Analog input 0-10 V The following choices can be made: <u>None</u> 0-10V Humidity sensor 0-10V CO ₂ sensor

* Inputs/outputs whose function depend on the chosen Flexit GO configuration. Underlined choice is default for an air handling unit configured for water heating.

** Max. voltage 230 V AC max. current 2A resistive load

12. Configuration

 = touch here

 = don't touch here

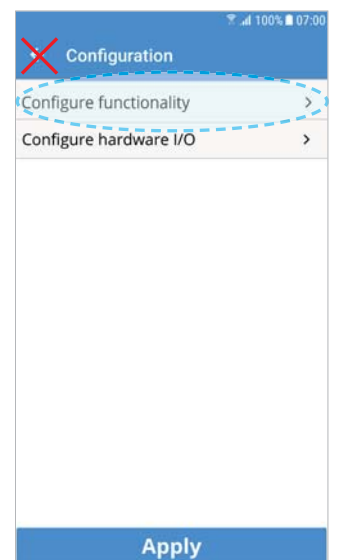
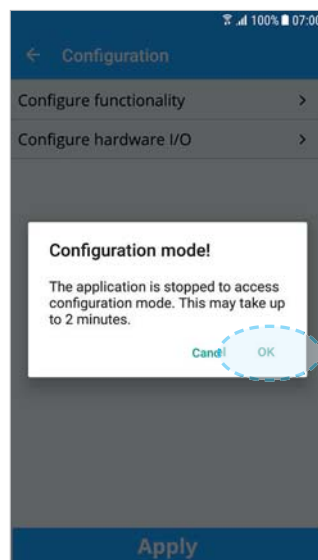
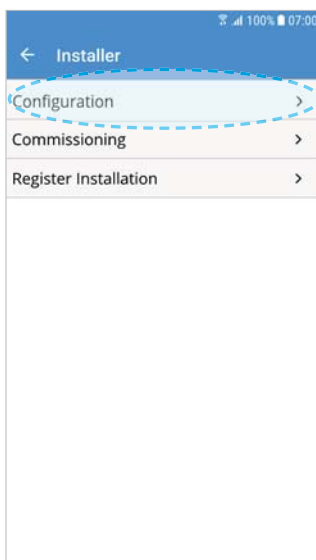
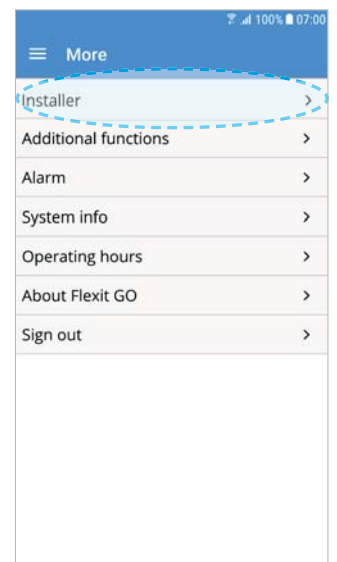
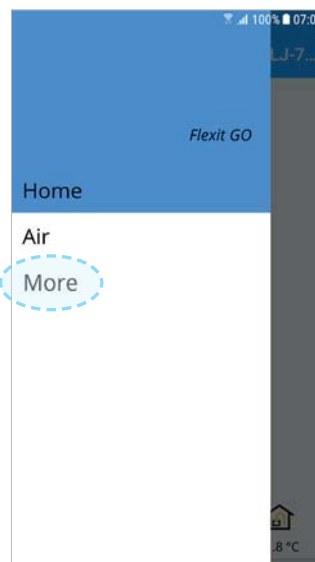
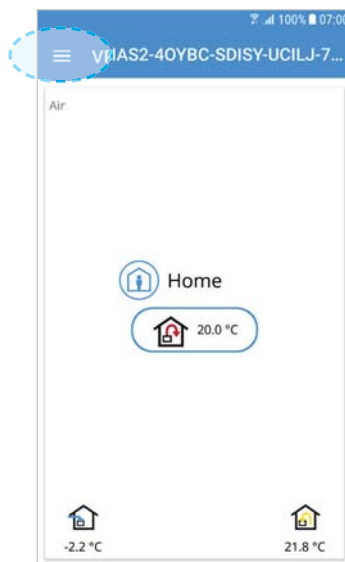
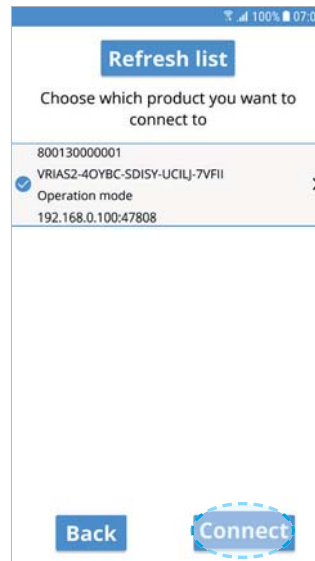
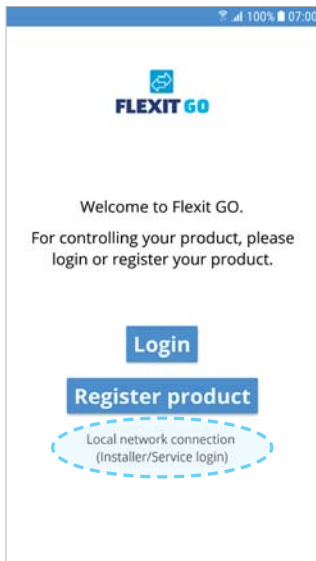

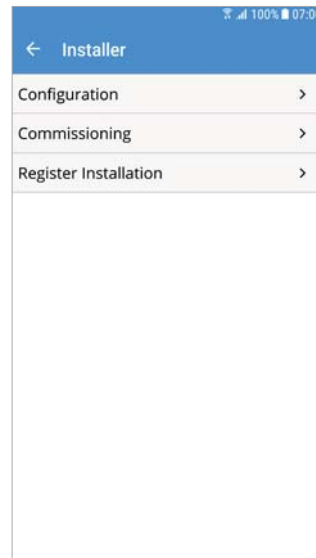
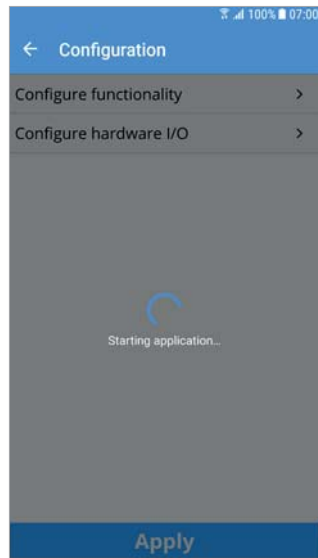
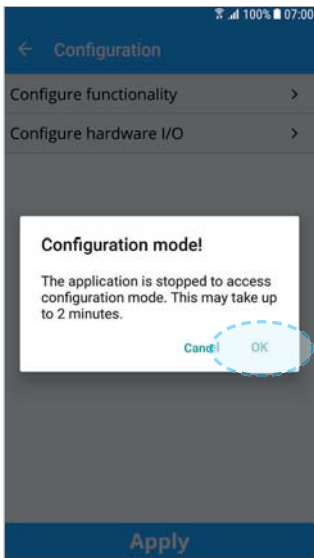
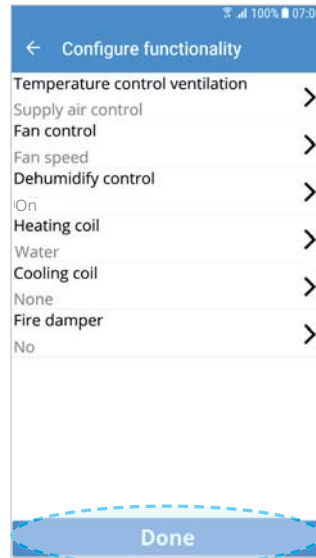
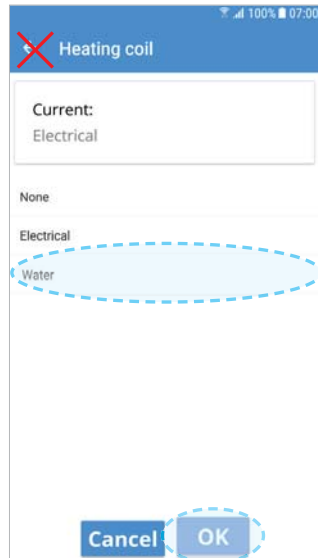
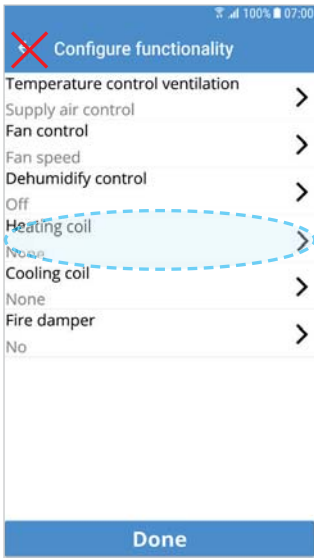

13. Maintenance

The lamellas in the heating element must be cleaned on a regular basis. First, clean the entry side of the element with a brush, then the whole element can be cleaned with compressed air, water or steam.

Blow the filth away from the outgoing end to the incoming end.

With the use of detergent, first make sure that it does not react with copper or aluminium.

Take care not to harm the thin lamellas during cleaning.

14. Accessories



Shunt valve:

- For continuous regulation of warm or cold water in open or closed circuits.
- Flow control of heater and coolers in climate installation.
- Bubble proof closing in closed mode.
- Cold or warm water that can be mixed with up to 50% vol. antifreeze.

3-way

3-port regulation valve with linear characteristics.

Inside thread connection Rp 1/2", DN 15
 Nickelcoated housing, heat-pressed brass
 Valve housing, stainless steel
 Sealer PTFE/EPDM O-ring
 ps 1600kPa

2-way

2-port regulation valve with effektilinjar (equal percent) characteristics.

Inside thread connection Rp 1/2", DN 15
 Nickelcoated housing, heat-pressed brass
 Valve housing, stainless steel
 Sealer PTFE/EPDM O-ring
 ps 1600kPa



Air damper with spring loaded closing Ø125

- LF230, Belimo
- AC 230V,
- 50/60Hz,
- 4Nm,
- 7VA,
- 5W
- With short cable 2x0,75mm².



Shunt valve motor:

AC 100-240V 50/60Hz
 Power consumption in operation 1,5W with rated torque
 in standby mode 0,4W, for dimensioning 4VA.
 Connection cable 1m 3x0,75mm²
 Torque Min5Nm at voltage
 Soundlevel Max 5dB(A) without valve
 Position indicator mechanical
 Protection class 2
 Protection class IP54

Overview	
14482	Air damper with spring loaded closing Ø160
14481	Air damper with spring loaded closing Ø200
56596	Shunt valve motor
Shunt valves	
110939	2-way valve DN15 Kvs. 0,25
110940	2-way valve DN15 Kvs. 0,4
110941	3-way valve DN15 Kvs. 0,25
110942	3-way valve DN15 Kvs. 0,4

111812	2-way valve DN15 Kvs. 0,63
111813	3-way valve DN15 Kvs. 0,63
111814	2-way valve DN15 Kvs. 1,0
111815	3-way valve DN15 Kvs. 1,0

15. Frost safety function in the ventilation system control system

To always minimize the risk of freezing of the water heating coil, 2-stage frost protection and additional idle time frost protection functions are available.

Frost protection function while unit is in operation:

Application uses 2-stage frost protection with 2 dedicated setpoints which firstly aims to prevent the freezing while allowing the ventilation still be normally active and secondly protecting the unit if prevention was insufficient. For this function B5 temperature sensor is mandatory and it must be **located** in the coldest place of the water heating coil.

Stage 1 - Frost risk:

When B5 temperature drops below settable frost risk setpoint (default 10°C), pump (output Y1) is switched on (if not already on) and valve (output X7) is controlled according to B5 (input X4) temperature to frost risk. When B5 temperature reaches frost risk SP-frost protection function is ended successfully.

Stage 2 – Frost protection:

When temperature at B5 (input X4) drops below settable frost protection setpoint (default 5°C), pump (output Y1) is switched on (if not on already), valve (output X7) is opened 100%, ventilation is shut down, possible outside air dampers are closed and A-alarm is activated. New start can only be made after manual acknowledgement and reset.

Protection function while unit is not in operation:

During the times when ventilation unit is switched off for some reason (power supply must exist), B5 (input X4) temperature has an additional setpoint (default +25°C) to secure start-up situation. When heating coil is constantly kept warm, it will not drop to frost protection limit during start-up even when the outside conditions are cold.

Pump (output Y1) runs constantly during ventilation unit off-periods. If the B5 (input X4) temperature drops during unit off times below set temperature limit, valve (output X7) is PI-controlled to reach idle setpoint. Alarm is not activated unless the temperature at B5 drops below frost protection setpoint.



Flexit AS, Televeien 15, N-1870 Ørje
www.flexit.no